

RECYFIX PRO

Corrosion-free drainage channels for private and public areas.





**European-quarter
in Frankfurt, Germany**

RECYFIX PRO

Corrosion-free drainage channels for private and public areas.

1 Requirements

Drainage channels for optically attractive areas have to

- be modern and unique in its design
- be extremely stable to guarantee long-term and permanent security
- be resistant to environmental influences (frost, heat and moisture)
- be dimensioned for high loading categories
- be designed in accordance with DIN EN 1433

2 Application areas

- private and public areas
- squares and parks
- railway platforms
- driveways and parking lots
- reduced trafficked areas

3 Solutions

Therefore RECYFIX PRO channels are suitable for the drainage of sophisticated areas:

- channel and angle housing made of 100 % recycled composite
- secure and corrosion-free grating support
- loading capacity up to C 250
- hydraulically optimised FIBRETEC slotted grating



100% corrosion-free

100% corrosion-free, especially with frost and de-icing salt



Platform in Limburg, Germany



Car park Andritz group Vienna, Austria



EACT Academy in Oldham Manchester, UK



School in Sunderland, UK

RECYFIX® PRO
RECYFIX® PLUS
RECYFIX® STANDARD
Facade Drainage
SLOTTED CHANNELS
RECYFIX® POINT FASERFIX® POINT
RECYFIX® GREEN
TOP X

YOUR BENEFITS WITH RECYFIX PRO

ANGLE HOUSING

- PP-angle housing 20 x 20 mm acc. to DIN 19580 for additional flexibility
- nibs to stop lateral movements
- inlaying gratings

= **PERFORMANCE ASSURED**



LOW WEIGHT ENSURES EASY HANDLING ON SITE

- much lighter than channels made of polymer/resin concrete
- easy transport and installation

= **TIME & COST SAVINGS**



HIGH RESISTANCE

- high resistance against frost, de-icing salt and UV-rays
- withstands high temperature differences
- for climate ranges from - 50 °C to + 80 °C and more

= **QUALITY ASSURED / LONGEVITY**



HIGH-GRADE MATERIAL

- **RECYFIX** – stable and almost unbreakable
- elastic and especially robust material
- withstands high loads and temperature differences in daily use
- 100 % recycled composite body (and also 100 % recyclable) → 100 % environmentally friendly
- 0 % water absorption
- smooth inner surface for superior flow characteristics
- non-conductive
- PP channel body can be cut, drilled and worked easily on site

= **QUALITY & PERFORMANCE ASSURED**



PRE-ASSEMBLED READY FOR INSTALLATION

- channel and grating = one part
- no spare parts
- easy handling in stock and on construction site
- cost-efficient transport

= **BETTER GROSS MARGIN**



IDEAL FOR ...

applications with corrosion-free linear drainage for private and public areas, such as parks, driveways and parking lots.

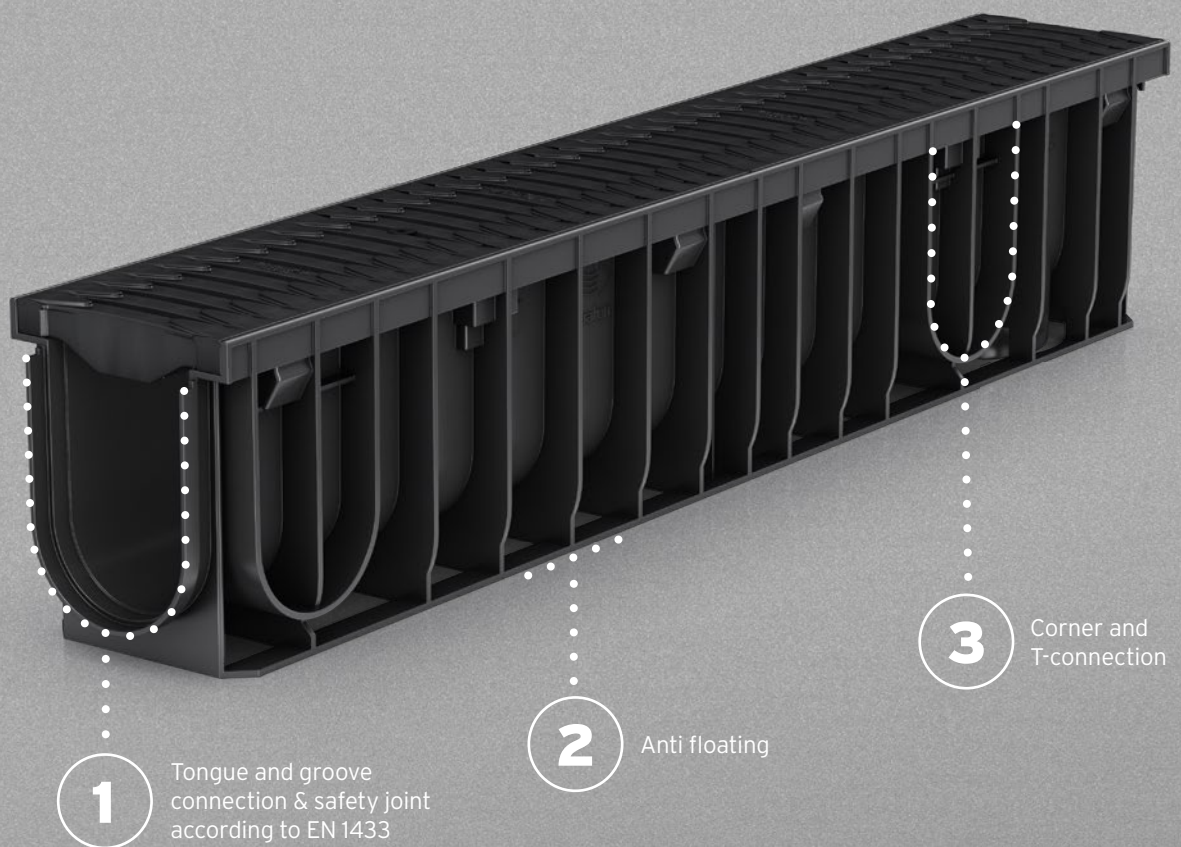

100 % corrosion-free

RECYFIX PRO

Corrosion-free drainage channels for private and public areas.

Modern office complex in Düsseldorf is drained with RECYFIX PRO.

RECYFIX PRO

In the centre of Düsseldorf, Germany on the area of some old barracks a new business world - named after the artist couple Clara & Robert Schumann - has arisen. Two new seven-storey buildings were built with the historical Saarhus where parts of the old facade were preserved and framed within the new facade of the modern office complex. The modern office complex offers a rental area of 16,500 square metres. Modern locations require modern drainage concepts. Around 300 metres of the RECYFIX PRO 100 type 010 have been installed with a ductile iron longitudinal grating in KTL.

The benefit for Landscaping Architects:

- Security in design and material
 - durable and reliable drainage system
 - fulfills all norms
- Harmonious architecture:
 - the filigree ductile iron longitudinal gratings blend in with the pavement and the anthracite-coloured windows

The benefit for Landscape Gardeners:

- Cost savings and back-friendly installation
 - low weight
 - easy installation and processing (cutting of fitting pieces and mitres)
 - easy transport to the construction site



**Clara & Robert
office complex,
Düsseldorf, Germany**



RECYFIX® PRO
RECYFIX® PLUS
RECYFIX® STANDARD
Facade Drainage
SLOTTED CHANNELS
RECYFIX® POINT FASERFIX® POINT
RECYFIX® GREEN
TOP X

RECYFIX PRO

Corrosion-free drainage channels for private and public areas.

RECYFIX PRO channels meet the requirements of DIN EN 1433 and are suitable for the following load categories:



Category A 15, Load class 15 kN



Category B 125, Load class 125 kN



Category C 250, Load class 250 kN



Category D 400, Load class 400 kN

If in doubt, the higher category should be used.

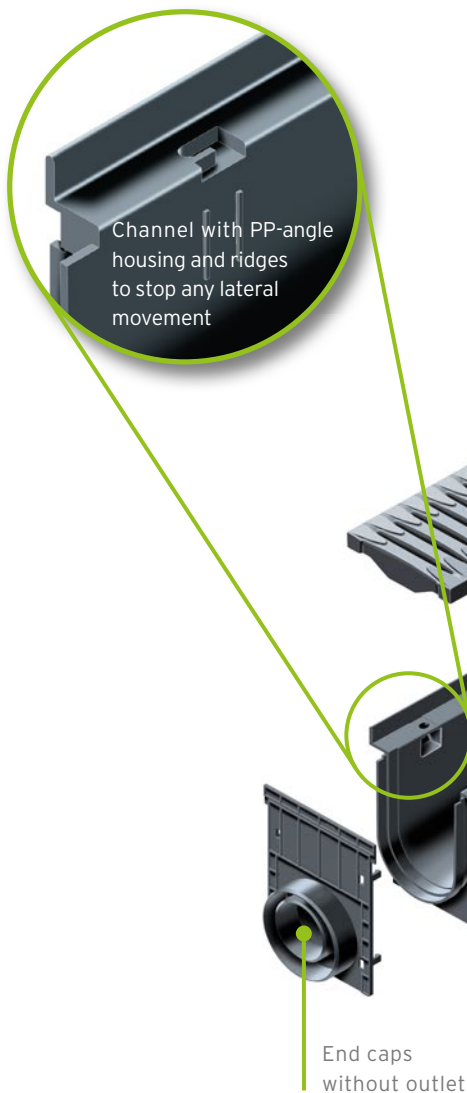

Channel with PP-angle housing and ridges to stop any lateral movement

Various grating options, for example **FIBRETEC** slotted grating

Channels made of PP, according to DIN V 19580 / EN 1433, CE-conform, with tongue and groove connection for exact installation

End caps without outlet

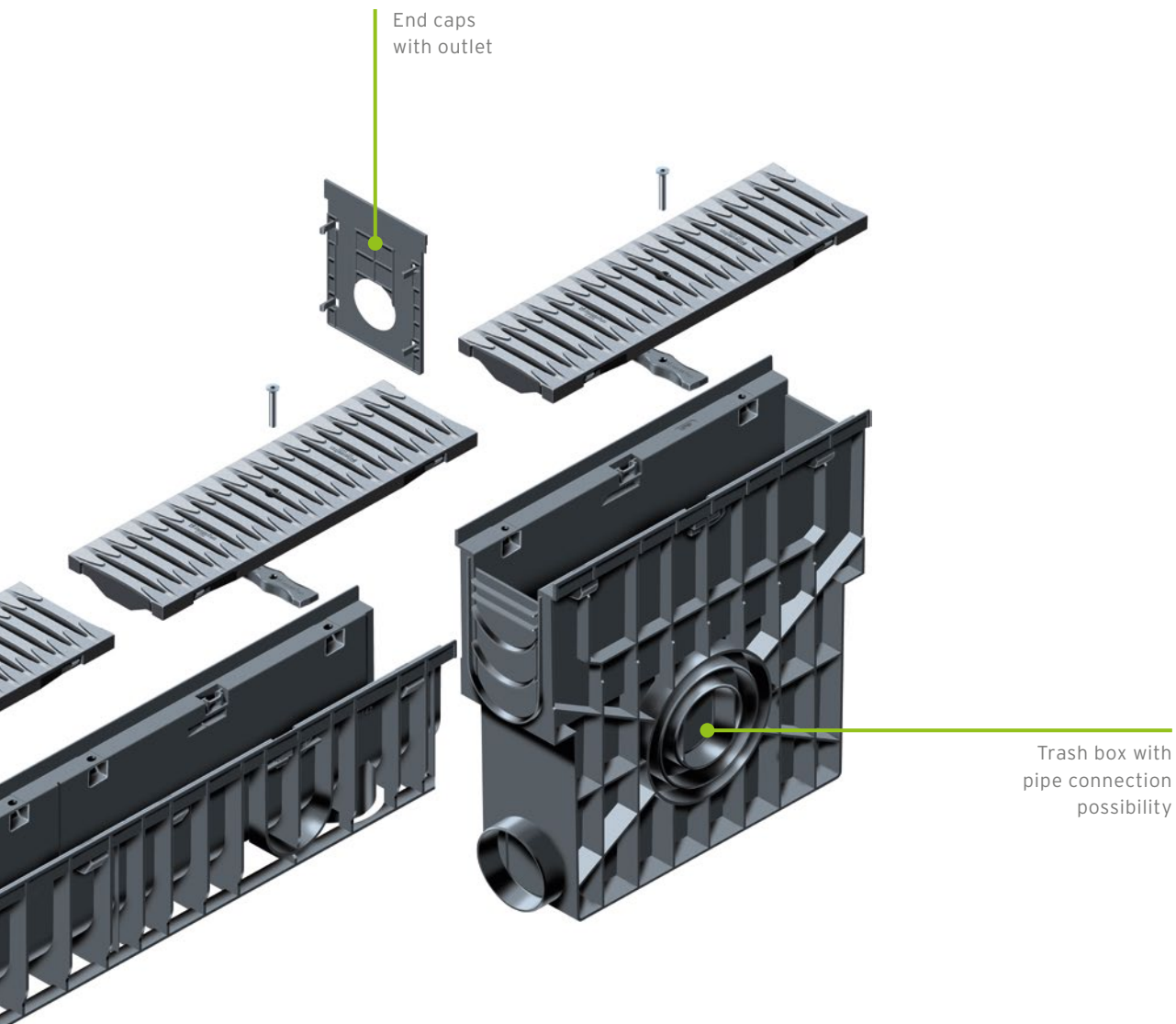

The construction widths and heights of the **RECYFIX PRO**:



Nominal width	100			150			200			300		
Type 75	160	75	55	-	-	-	-	-	-	-	-	-
Type 95	160	95	75	-	-	-	-	-	-	-	-	-
Type 115	-	-	-	212	115	95	262	115	95	-	-	-
Type 01	160	150	122	212	210	180	-	-	-	-	-	-
Type 010	160	200	172	-	-	-	262	200	172	362	360	320
Type 020	160	250	222	-	-	-	-	-	-	-	-	-

Width/height/inner height (in mm)

- RECYFIX[®] PRO
- RECYFIX[®] PLUS
- RECYFIX[®] STANDARD
- Facade Drainage
- SLOTTED CHANNELS
- RECYFIX[®] POINT
FASERFIX[®] POINT
- RECYFIX[®] GREEN
- TOP X

The new style of drainage!

Artistically combined, uniquely attractive: coloured FIBRETEC gratings.

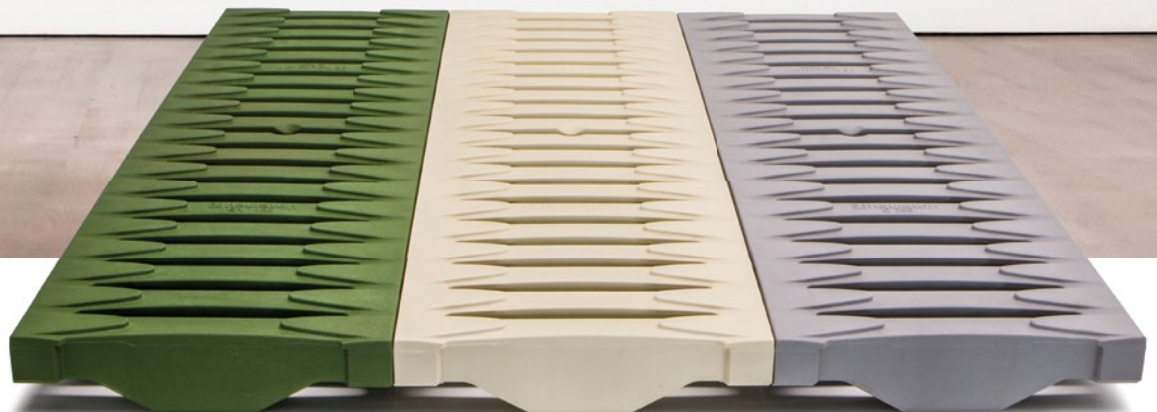

FIBRETEC

The art of drainage has many styles. With the coloured **FIBRETEC** gratings, HAURATON creates a completely new scope of design.

The unique channel gratings in the colours Fern, Sand and Stone can be combined with different materials. Thus, new compositions of colours and textures can always be created. As desired, the coloured FIBRETEC gratings can accentuate the colour composition of the surroundings or harmonise as a complete work of art.



Inspiration for the new gratings was the proven black FIBRETEC which has received various awards since its introduction in 2010. One of which is the International Design Award Baden-Württemberg Focus Open.



The production of the coloured FIBRETEC gratings in the colours Fern, Sand and Stone is done with coloured granulate. The result is uniformly coloured gratings which are particularly weather and UV-resistant. This was tested and approved in the laboratory according to DIN EN ISO 4892-2 as required by DIN 19580: The gratings were exposed to artificial weathering for a total of 1,600 hours in the form of xenon arc radiation and irrigation.

The subsequent mechanical tests were very successful - optical changes were hardly measurable. However, slight long-term colour changes in the material cannot be ruled out.

FIBRETEC in Fern

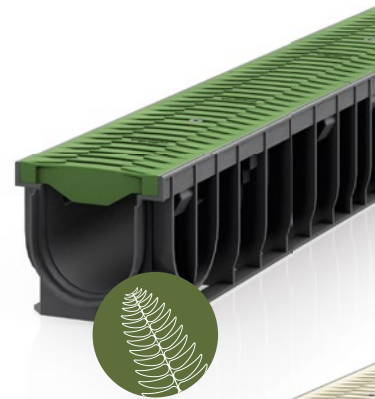

FIBRETEC in Sand



FIBRETEC in Stone



FIBRETEC in Black



METROPOLIS

Inspired from history - Made for the future

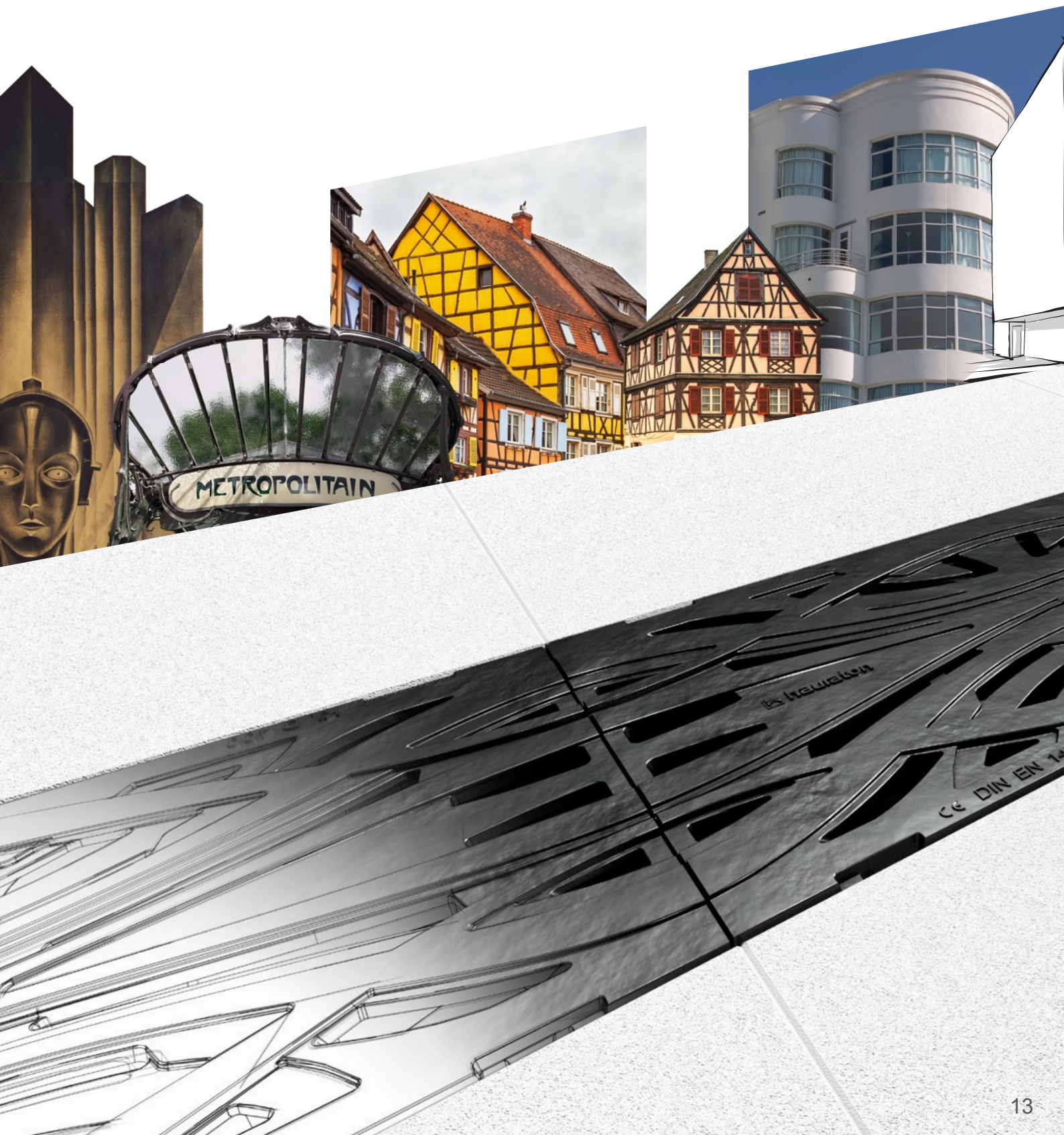

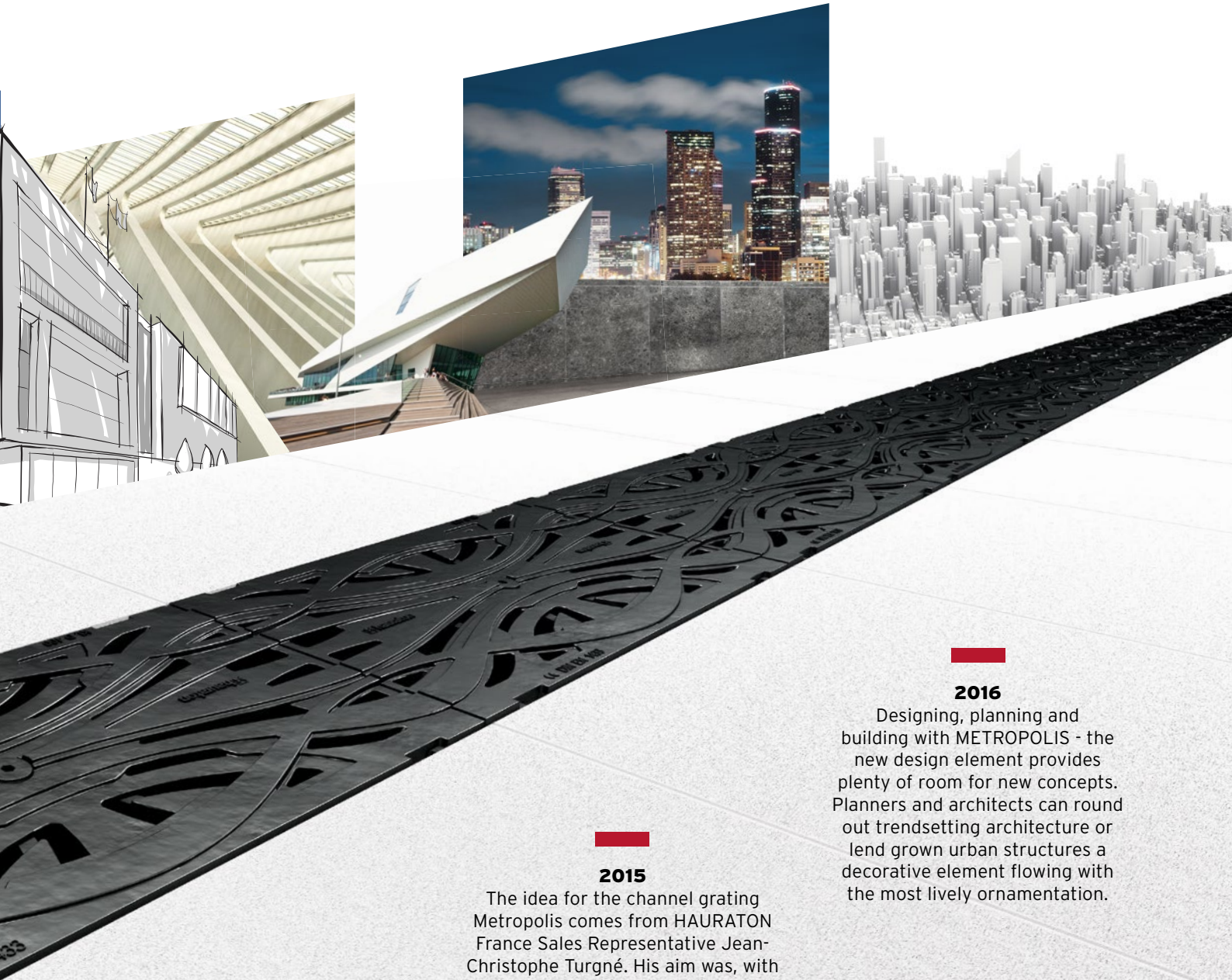

1927

The movie 'Metropolis', by Fritz Lang, has influenced various genres since its creation in 1927. With the expressionist representation of a futuristic metropolis, the film producer developed a leitmotif that still inspires artists and designers today.

2015

The idea for the channel grating Metropolis comes from HAURATON France Sales Representative Jean-Christophe Turgné. His aim was, with a functional component such as the drainage channel, to set standards with respect to aesthetics and to impart specific construction projects with futuristic, decorative details.

2016

Designing, planning and building with METROPOLIS - the new design element provides plenty of room for new concepts. Planners and architects can round out trendsetting architecture or lend grown urban structures a decorative element flowing with the most lively ornamentation.

Grating options

RECYFIX PRO 100

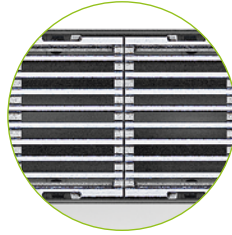

Longitudinal ductile iron gratings, galvanised

Bar distance: 9 mm

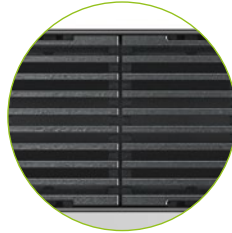

Longitudinal ductile iron gratings, KTL

Bar distance: 9 mm

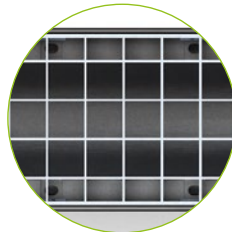

Mesh gratings, galvanised

Mesh width: 30 x 30 mm

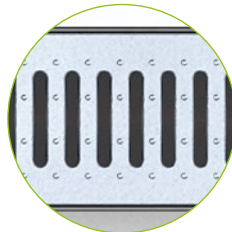

Slotted gratings and reinforced slotted gratings, galvanised and stainless steel

Bar distance: 80 x 10 mm



GUGI-Mesh gratings, composite material

Mesh width: 15 x 25 mm

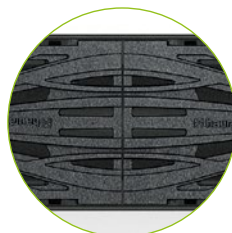

Ductile iron grating, METROPOLIS, KTL

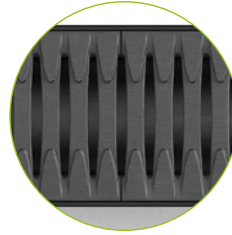

**FIBRETEC
Slotted gratings,
in Black**

Bar distance: 9 mm

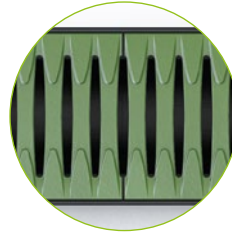
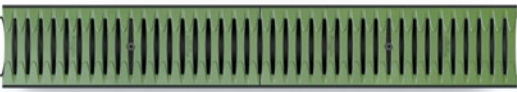

**FIBRETEC
Slotted gratings,
in Fern**

Bar distance: 9 mm

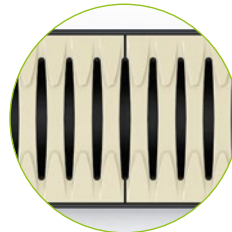

**FIBRETEC
Slotted gratings,
in Sand**

Bar distance: 9 mm

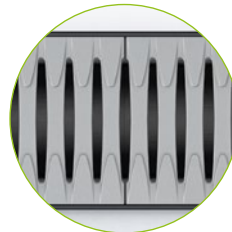

**FIBRETEC
Slotted gratings,
in Stone**

Bar distance: 9 mm

Seven new colors of
FIBRETEC Design gratings
can be found on page 31

RECYFIX® PRO
RECYFIX® PLUS
RECYFIX® STANDARD
Facade Drainage
SLOTTED CHANNELS
RECYFIX® POINT FASERFIX® POINT
RECYFIX® GREEN
TOP X

RECYFIX®PRO 100

Combi article

RECYFIX®PRO 100, class B 125

Type 01 with GUGI-Grating
made of PA-GF, MW 15/25 mm,
black, locked

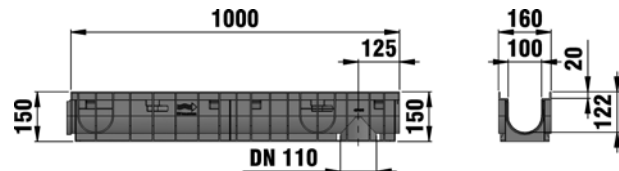
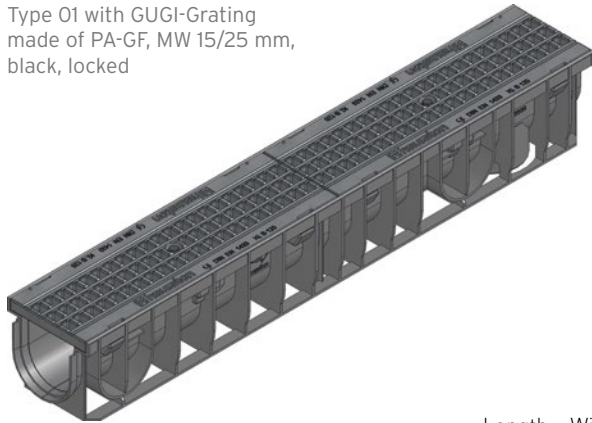

	Length mm	Width mm	Height mm	Internal channel cross-sect. cm ²	Intake cross-sect. cm ² /m	Weight kg	Item-No. galvanised	Item-No. stainless steel
Type 01 with GUGI-Grating made of PA-GF, MW 15/25 mm, black, locked, 1,0 m	1000	160	150	92	444	4,26	47035	-
Type 0105 with GUGI-Grating made of PA-GF, MW 15/25 mm, black, locked, 0,5 m	500	160	150	92	444	2,07	47036	-
Type 010 with GUGI-Grating made of PA-GF, MW 15/25 mm, black, locked, 1,0 m	1000	160	200	142	444	4,66	47040	-
Type 01005 with GUGI-Grating made of PA-GF, MW 15/25 mm, black, locked, 0,5 m	500	160	200	142	444	2,53	47041	-
Type 020 with GUGI-Grating made of PA-GF, MW 15/25 mm, black, locked, 1,0 m	1000	160	250	192	444	5,50	48623	-
Type 02005 with GUGI-Grating made of PA-GF, MW 15/25 mm, black, locked, 0,5 m	500	160	250	192	444	2,80	48673	-
Type 75 with GUGI-Grating made of PA-GF, MW 15/25 mm, black, locked, 1,0 m*	1000	160	75	35	444	2,94	47032	-
Type 95 with GUGI-Grating made of PA-GF, MW 15/25 mm, black, locked, 1,0 m	1000	160	95	55	444	3,60	47033	-
Type 01 with mesh grating, MW 30/10 mm, locked, 1,0 m	1000	160	150	92	1099	6,05	47034	47037
Type 0105 with mesh grating, MW 30/10 mm, locked, 0,5 m	500	160	150	92	1080	3,02	47157	47158
NEW Type 010 with mesh grating MW 30/10 mm, locked, 1,0 m	1000	160	200	142	1099	6,56	47071	47073
NEW Type 01005 with mesh grating MW 30/10 mm, locked, 0,5 m	500	160	200	142	1080	3,34	47079	47080
NEW Type 020 with mesh grating MW 30/10 mm, locked, 1,0 m	1000	160	250	192	1099	7,45	10098	10099
NEW Type 02005 with mesh grating MW 30/10 mm, locked, 0,5 m	1000	160	250	192	1080	3,78	47098	47092
NEW Type 75 with mesh grating, MW 30/10, locked, 1,0 m	1000	160	75	35	1099	5,02	47001	47020
NEW Type 95 with mesh grating MW 30/10 mm, locked, 1,0 m	1000	160	95	55	1099	5,55	47094	47096

* For frequently used areas we recommend FASERFIX KS channels shallow (see CIVILS).
The quality of stainless steel material corresponds to CNS 1.4301.

RECYFIX® PRO 100

RECYFIX® PRO 100, class C 250

Type 01 with FIBRETEC design slotted grating, SW 9 mm, in the colour black, locked, 1,0 m

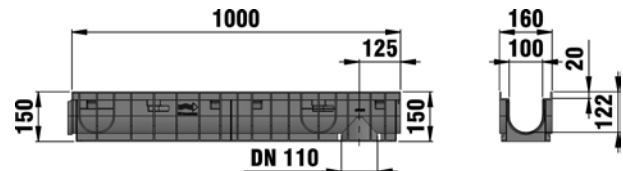
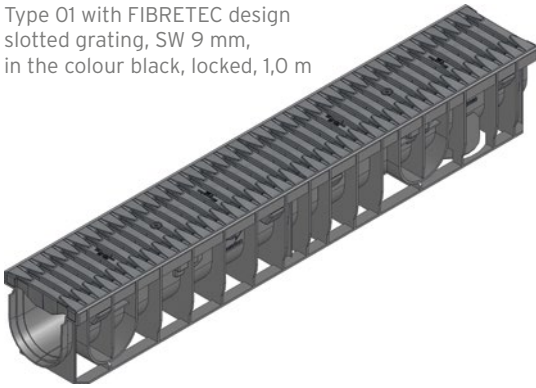

	Length mm	Width mm	Height mm	Internal channel cross-sect. cm ²	Intake cross-sect. cm ² /m	Weight kg	Item-No. galvanised	Item-No. stainless steel
Type 01 with FIBRETEC design slotted grating, SW 9 mm, in the colour black, locked, 1,0 m	1000	160	150	92	372	4,60	47055	-
Type 0105 with FIBRETEC design slotted grating, SW 9 mm, in the colour black, locked, 0,5 m	500	160	150	92	372	2,26	47056	-
Type 010 with FIBRETEC design slotted grating, SW 9 mm, in the colour black, locked, 1,0 m	1000	160	200	142	372	4,89	47060	-
Type 01005 with FIBRETEC design slotted grating, SW 9 mm, in the colour black, locked, 0,5 m	500	160	200	142	372	2,49	47061	-
Type 020 with FIBRETEC design slotted grating, SW 9 mm, in the colour Black, locked, 1,0 m	1000	160	250	192	372	5,76	48625	-
Type 02005 with FIBRETEC design slotted grating, SW 9 mm, in the colour Black, locked, 0,5 m	500	160	250	192	372	2,95	48675	-
Type 75 with FIBRETEC design slotted grating, SW 9 mm, in the colour black, locked, 1,0 m	1000	160	75	35	372	3,45	47062	-
Type 95 with FIBRETEC design slotted grating, SW 9 mm, in the colour black, locked, 1,0 m	1000	160	95	55	372	3,68	47063	-
Type 01 with FIBRETEC design slotted grating, SW 9 mm, in the colour Sand, locked, 1,0 m	1000	160	150	92	372	4,35	47405	-
Type 0105 with FIBRETEC design slotted grating, SW 9 mm, in the colour Sand, locked, 0,5 m	500	160	150	92	372	2,12	47421	-
Type 010 with FIBRETEC design slotted grating, SW 9 mm, in the colour Sand, locked, 1,0 m	1000	160	200	142	372	4,89	47406	-
Type 01005 with FIBRETEC design slotted grating, SW 9 mm, in the colour Sand, locked, 0,5 m	500	160	200	142	372	2,44	47422	-
Type 020 with FIBRETEC design slotted grating, SW 9 mm, in the colour Sand, locked, 1,0 m	1000	160	250	192	372	5,76	47407	-
Type 02005 with FIBRETEC design slotted grating, SW 9 mm, in the colour Sand, locked, 0,5 m	500	160	250	192	372	2,88	47423	-
Type 75 with FIBRETEC design slotted grating, SW 9 mm, in the colour Sand, locked, 1,0 m*	1000	160	75	35	372	3,33	47403	-
Type 95 with FIBRETEC design slotted grating, SW 9 mm, in the colour Sand, locked, 1,0 m	1000	160	95	55	372	3,68	47404	-

* For frequently used areas we recommend FASERFIX KS channels shallow (see CIVILS).

RECYFIX®
PRO

RECYFIX®
PLUS

RECYFIX®
STANDARD

Facade Drainage

SLOTTED
CHANNELS

RECYFIX® POINT
FASERFIX® POINT

RECYFIX®
GREEN

TOP X

RECYFIX®PRO 100

Combi article

RECYFIX®PRO 100, class C 250

Type 010 with FIBRETEC design
slotted grating SW 9 mm,
in the colour Fern, locked, 1,0 m

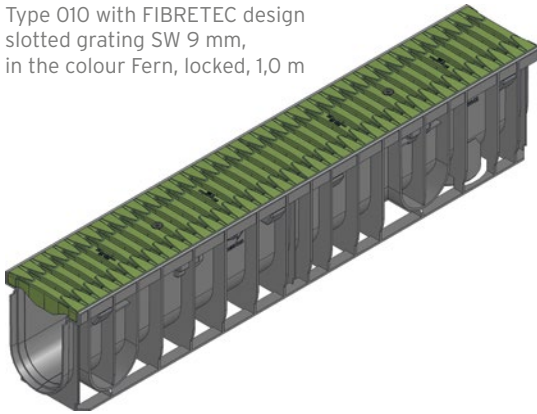

Type 020 with FIBRETEC design
slotted grating SW 9 mm,
in the colour Stone, locked, 1,0 m

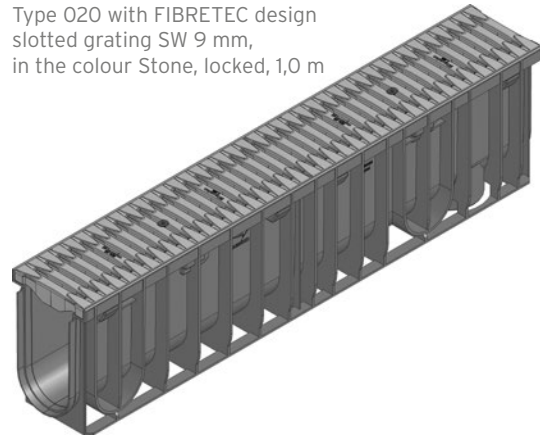

	Length mm	Width mm	Height mm	Internal channel cross-sect. cm ²	Intake cross-sect. cm ² /m	Weight kg	Item-No. galvanised	Item-No. stainless steel
Type 01 with FIBRETEC design slotted grating, SW 9 mm, in the colour Fern, locked, 1,0 m	1000	160	150	92	372	4,60	47417	-
Type 0105 with FIBRETEC design slotted grating, SW 9 mm, in the colour Fern, locked, 0,5 m	500	160	150	92	372	2,12	47427	-
Type 010 with FIBRETEC design slotted grating, SW 9 mm, in the colour Fern, locked, 1,0 m	1000	160	200	142	372	4,86	47418	-
Type 01005 with FIBRETEC design slotted grating, SW 9 mm, in the colour Fern, locked, 0,5 m	500	160	200	142	372	2,44	47428	-
Type 020 with FIBRETEC design slotted grating, SW 9 mm, in the colour Fern, locked, 1,0 m	1000	160	250	192	372	5,76	47419	-
Type 02005 with FIBRETEC design slotted grating, SW 9 mm, in the colour Fern, locked, 0,5 m	500	160	250	192	372	2,88	47429	-
Type 75 with FIBRETEC design slotted grating, SW 9 mm, in the colour Fern, locked, 1,0 m*	1000	160	75	35	372	3,45	47415	-
Type 95 with FIBRETEC design slotted grating, SW 9 mm, in the colour Fern, locked, 1,0 m	1000	160	95	55	372	3,68	47416	-
Type 01 with FIBRETEC design slotted grating, SW 9 mm, in the colour Stone, locked, 1,0 m	1000	160	150	92	372	4,35	47411	-
Type 0105 with FIBRETEC design slotted grating, SW 9 mm, in the colour Stone, locked, 0,5 m	500	160	150	92	372	2,12	47424	-
Type 010 with FIBRETEC design slotted grating, SW 9 mm, in the colour Stone, locked, 1,0 m	1000	160	200	142	372	4,89	47412	-
Type 01005 with FIBRETEC design slotted grating, SW 9 mm, in the colour Stone, locked, 0,5 m	500	160	200	142	372	2,44	47425	-
Type 020 with FIBRETEC design slotted grating, SW 9 mm, in the colour Stone, locked, 1,0 m	1000	160	250	192	372	5,76	47413	-
Type 02005 with FIBRETEC design slotted grating, SW 9 mm, in the colour Stone, locked, 0,5 m	500	160	250	192	372	2,88	47426	-
Type 75 with FIBRETEC design slotted grating, SW 9 mm, in the colour Stone, locked, 1,0 m*	1000	160	75	35	372	3,45	47409	-
Type 95 with FIBRETEC design slotted grating, SW 9 mm, in the colour Stone, locked, 1,0 m	1000	160	95	55	372	3,68	47410	-

* For frequently used areas we recommend FASERFIX KS channels shallow (see CIVILS).

RECYFIX® PRO 100

NEW RECYFIX® PRO 100, class C 250, FIBRETEC Design gratings in new colours

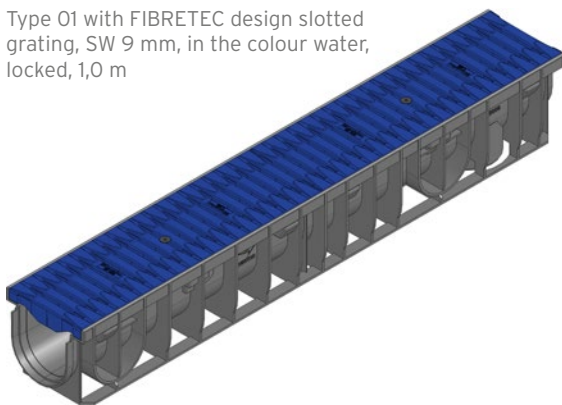

Type 01 with FIBRETEC design slotted grating, SW 9 mm, in the colour water, locked, 1,0 m

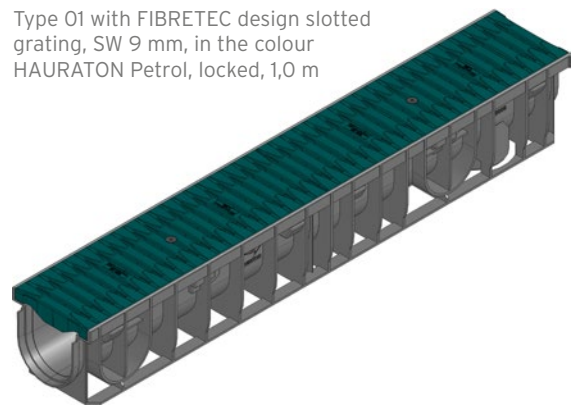

Type 01 with FIBRETEC design slotted grating, SW 9 mm, in the colour HAURATON Petrol, locked, 1,0 m

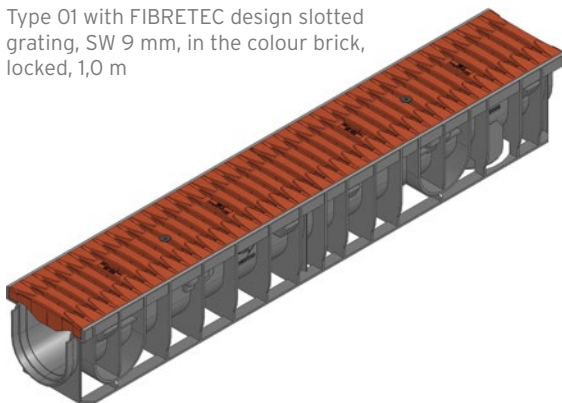

Type 01 with FIBRETEC design slotted grating, SW 9 mm, in the colour brick, locked, 1,0 m

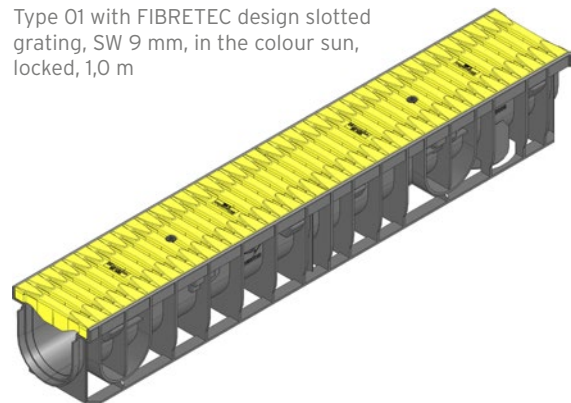

Type 01 with FIBRETEC design slotted grating, SW 9 mm, in the colour sun, locked, 1,0 m

	Length mm	Width mm	Height mm	Internal channel cross-sect. cm ²	Intake cross-sect. cm ² /m	Weight kg	Item No.
Type 01 with FIBRETEC design slotted grating, SW 9 mm, in the colour water, locked, 1,0 m	1000	160	150	92	372	4,35	47438
Type 01 with FIBRETEC design slotted grating, SW 9 mm, in the colour HAURATON Petrol, locked, 1,0 m	1000	160	150	92	372	4,35	47439
Type 01 with FIBRETEC design slotted grating, SW 9 mm, in the colour Corten, locked, 1,0 m	1000	160	150	92	372	4,35	47440
Type 01 with FIBRETEC design slotted grating, SW 9 mm, in the colour aluminium, locked, 1,0 m	1000	160	150	92	372	4,35	47441
Type 01 with FIBRETEC design slotted grating, SW 9 mm, in the colour brick, locked, 1,0 m	1000	160	150	92	372	4,35	47442
Type 01 with FIBRETEC design slotted grating, SW 9 mm, in the colour slate, locked, 1,0 m	1000	160	150	92	372	4,35	47443
Type 01 with FIBRETEC design slotted grating, SW 9 mm, in the colour sun, locked, 1,0 m	1000	160	150	92	372	4,35	47444

RECYFIX®
PRO

RECYFIX®
PLUS

RECYFIX®
STANDARD

Facade Drainage

SLOTTED
CHANNELS

RECYFIX® POINT
FASERFIX® POINT

RECYFIX®
GREEN

TOP X

RECYFIX®PRO 100

Combi article

NEW RECYFIX®PRO 100, class C 250, FIBRETEC Design grating, with slip resistance class R11

Type 01 with FIBRETEC design slotted grating SW 9 mm, black, locked, slip resistance class R11, 0,5 m

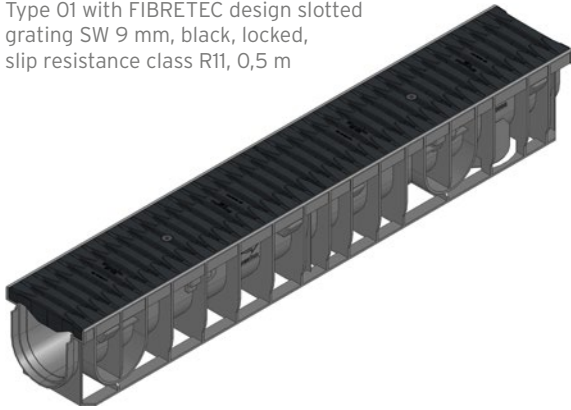

Type 75 with FIBRETEC design slotted grating SW 9 mm, in the colour black, locked, slip resistance class R11, 1,0 m

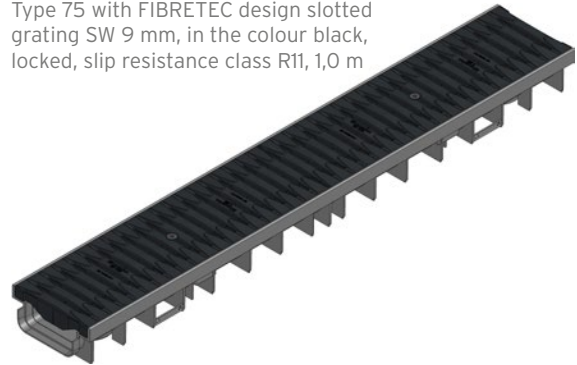

	Length mm	Width mm	Height mm	Internal channel cross-sect. cm ²	Intake cross-sect. cm ² /m	Weight kg	Item No.
Type 01 with FIBRETEC design slotted grating SW 9 mm, black, locked, slip resistance class R11, 0,5 m	1000	160	150	92	372	4,35	10221
Type 0105 with FIBRETEC design slotted grating SW 9 mm, black, locked, slip resistance class R11, 0,5 m	500	160	150	92	372	2,12	10222
Type 010 with FIBRETEC design slotted grating SW 9 mm, black, locked, slip resistance class R11, 1,0 m	1000	160	200	142	444	4,89	10217
Type 01005 with FIBRETEC design slotted grating SW 9 mm, black, locked, slip resistance class R11, 0,5 m	500	160	200	142	444	2,44	10218
Type 020 with FIBRETEC design slotted grating SW 9 mm, black, locked, slip resistance class R11, 0,5 m	1000	160	250	192	444	4,35	10219
Type 02005 with FIBRETEC design slotted grating SW 9 mm, black, locked, slip resistance class R11, 0,5 m	500	160	250	192	444	2,88	10220
Type 75 with FIBRETEC design slotted grating SW 9 mm, in the colour black, locked, slip resistance class R11, 1,0 m	1000	160	75	35	1099	3,33	10224
Type 95 with FIBRETEC design slotted grating SW 9 mm, in the colour black, locked, slip resistance class R11, 1,0 m	1000	160	95	55	1099	3,76	10226

RECYFIX® PRO 100

RECYFIX® PRO 100, class C 250

Type 010 with ductile longitudinal grating, SW 9 mm, KTL-coated, locked, 1,0 m

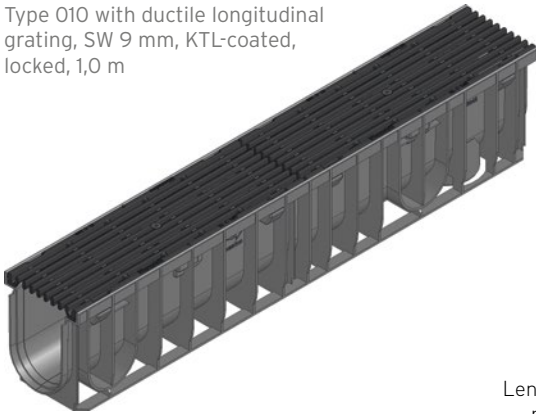

Type 75 with reinforced slotted grating, galvanised, SW 80/10 mm, locked, 1,0 m*

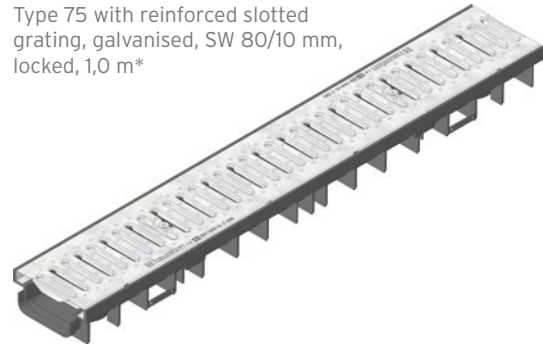

	Length mm	Width mm	Height mm	Internal channel cross-sect. cm ²	Intake cross-sect. cm ² /m	Weight kg	Item-No. galvanised	Item-No. stainless steel
Type 01 with ductile longitudinal grating, SW 9 mm, KTL-coated, locked, 1,0 m	1000	160	150	92	528	9,55	48634	-
Type 0105 with ductile longitudinal grating, SW 9 mm, KTL-coated, locked, 0,5 m	500	160	150	92	528	4,72	48635	-
Type 010 with ductile longitudinal grating, SW 9 mm, KTL-coated, locked, 1,0 m	1000	160	200	142	528	10,06	48645	-
Type 01005 with ductile longitudinal grating, SW 9 mm, KTL-coated, locked, 0,5 m	500	160	200	142	528	5,55	48646	-
Type 020 with longitudinal ductile iron grating, SW 9 mm, KTL-coated, locked, 1,0 m	1000	160	250	192	528	11,38	48626	-
Type 02005 with longitudinal ductile iron grating, SW 9 mm, KTL-coated, locked, 0,5 m	500	160	250	192	528	5,69	48676	-
Type 75 with ductile longitudinal grating, SW 9 mm, KTL-coated, locked, 1,0 m*	1000	160	75	35	528	8,53	47038	-
Type 95 with ductile longitudinal grating, SW 9 mm, KTL-coated, locked, 1,0 m	1000	160	95	55	528	8,96	47039	-
Type 01 with longitudinal ductile iron grating, SW 9 mm, galvanised, locked, 1,0 m	1000	160	150	92	528	9,56	48636	-
Type 0105 with longitudinal ductile iron grating, SW 9 mm, galvanised, locked, 0,5 m	500	160	150	92	528	5,22	48637	-
Type 010 with longitudinal ductile iron grating, SW 9 mm, galvanised, locked, 1,0 m	1000	160	200	142	528	10,07	48647	-
Type 01005 with longitudinal ductile iron grating, SW 9 mm, galvanised, locked, 0,5 m	500	160	200	142	528	5,04	48648	-
Type 75 with longitudinal ductile iron grating, SW 9 mm, galvanised, locked, 1,0 m*	1000	160	75	35	528	8,53	47068	-
Type 95 with longitudinal ductile iron grating, SW 9 mm, galvanised, locked, 1,0 m	1000	160	95	55	528	8,92	47069	-
Type 01 with reinforced slotted grating, SW 80/10 mm, locked, 1,0 m	1000	160	150	92	281	7,30	47074	47084
Type 0105 with reinforced slotted grating, SW 80/10 mm, locked, 0,5 m	500	160	150	92	281	3,67	47075	47085
Type 010 with reinforced slotted grating, SW 80/10 mm, locked, 1,0 m	1000	160	200	142	281	7,59	47076	47086
Type 01005 with reinforced slotted grating, SW 80/10 mm, locked, 0,5 m	500	160	200	142	281	3,99	47077	47087
Type 020 with reinforced slotted grating, SW 80/10 mm, locked, 1,0 m	1000	160	250	192	281	9,00	48627	48628
Type 02005 with reinforced slotted grating, SW 80/10 mm, locked, 0,5 m	500	160	250	192	281	4,50	48677	48678
Type 75 with reinforced slotted grating, galvanised, SW 80/10 mm, locked, 1,0 m*	1000	160	75	35	281	6,46	47014	47016
Type 95 with reinforced slotted grating, galvanised, SW 80/10 mm, locked, 1,0 m	1000	160	95	55	281	6,87	47015	47017

* For frequently used areas we recommend FASERFIX KS channels shallow (see CIVILS).
The quality of stainless steel material corresponds to CNS 1.4301.

RECYFIX®
PRO

RECYFIX®
PLUS

RECYFIX®
STANDARD

Facade Drainage

SLOTTED
CHANNELS

RECYFIX® POINT
FASERFIX® POINT

RECYFIX®
GREEN

TOP X

RECYFIX®PRO 100

Combi article

RECYFIX®PRO 100, class D 400

Type 01 with ductile iron design
grating METROPOLIS, black,
KTL-coated, locked, 1,0 m

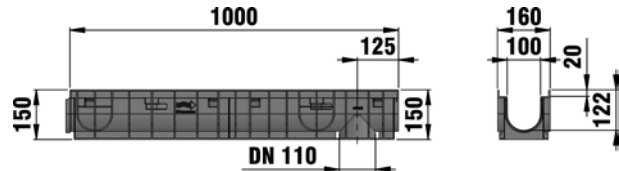
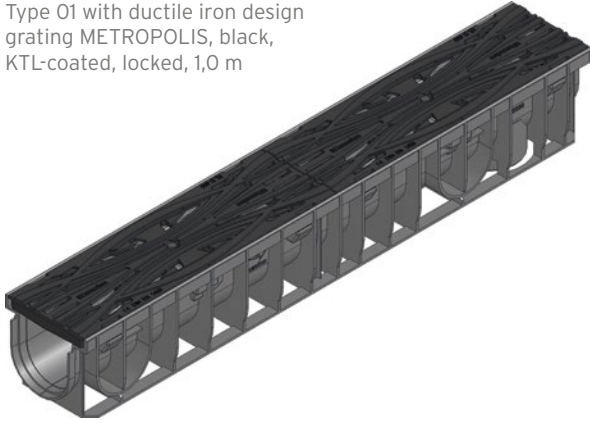

	Length mm	Width mm	Height mm	Internal channel cross-sect. cm ²	Intake cross-sect. cm ² /m	Weight kg	Item No.
Type 01 with ductile iron design grating METROPOLIS, black, KTL-coated, locked, 1,0 m	1000	160	150	92	165	12,48	47002
Type 0105 with ductile iron design grating METROPOLIS, black, KTL-coated, locked, 0,5 m	500	160	150	92	165	6,24	47003
Type 010 with ductile iron design grating METROPOLIS, black, KTL-coated, locked, 1,0 m	1000	160	200	142	165	12,92	47057
Type 01005 with ductile iron design grating METROPOLIS, black, KTL-coated, locked, 0,5 m	500	160	200	142	165	6,50	47058
Type 020 with ductile iron design grating METROPOLIS, black, KTL-coated, locked, 1,0 m	1000	160	250	192	165	13,90	48618
Type 02005 with ductile iron design grating METROPOLIS, black, KTL-coated, locked, 0,5 m	500	160	250	192	165	6,93	48619
Type 75 with ductile iron design grating METROPOLIS, black, KTL-coated, locked, 1,0 m	1000	160	75	35	165	11,40	47008
Type 95 with ductile iron design grating METROPOLIS, black, KTL-coated, locked, 1,0 m	1000	160	95	55	165	11,81	47009
Type 01 with longitudinal ductile iron grating, SW 9 mm, KTL-coated, locked, 1,0 m	1000	160	150	92	528	10,43	48630
Type 0105 with longitudinal ductile iron grating, SW 9 mm, KTL-coated, locked, 0,5 m	500	160	150	92	528	5,21	48631
Type 010 with longitudinal ductile iron grating, SW 9 mm, KTL-coated, locked, 1,0 m	1000	160	200	142	528	11,14	48640
Type 01005 with longitudinal ductile iron grating, SW 9 mm, KTL-coated, locked, 0,5 m	500	160	200	142	528	5,54	48641
Type 75 with longitudinal ductile iron grating, SW 9 mm, KTL-coated, locked, 1,0 m*	1000	160	75	35	528	9,52	47064
Type 95 with longitudinal ductile iron grating, SW 9 mm, KTL-coated, locked, 1,0 m	1000	160	95	55	528	9,96	47065
Type 020 with longitudinal ductile iron grating, bar spacing 9 mm, black, KTL-coated, bolted, 1,0 m	1000	160	250	192	528	11,96	48638
Type 02005 with longitudinal ductile iron grating bar spacing 9 mm, black, KTL-coated, bolted, 0,5 m	500	160	250	192	528	5,98	48639
Type 01 with longitudinal ductile iron grating, SW 9 mm, galvanised, locked, 1,0 m	1000	160	150	92	528	10,43	48632
Type 0105 with longitudinal ductile iron grating, SW 9 mm, galvanised, locked, 0,5 m	500	160	150	92	528	5,22	48633
Type 010 with longitudinal ductile iron grating, SW 9 mm, galvanised, locked, 1,0 m	1000	160	200	142	528	11,14	48643
Type 01005 with longitudinal ductile iron grating, SW 9 mm, galvanised, locked, 0,5 m	500	160	200	142	528	5,54	48644
Type 75 with longitudinal ductile iron grating, SW 9 mm, galvanised, locked, 1,0 m*	1000	160	75	35	528	9,52	47066
Type 95 with longitudinal ductile iron grating, SW 9 mm, galvanised, locked, 1,0 m	1000	160	95	55	528	9,96	47067

RECYFIX® PRO 100

Accessories

Trash boxes

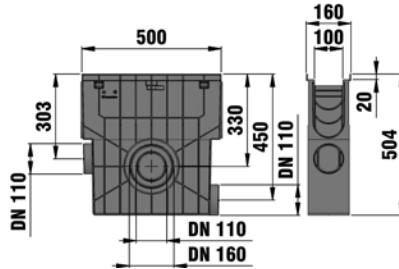

Trash box with PE mud bucket and slotted grating, SW 80/10 mm, class A 15, locked, 0,5 m



Trash box with galvanised mud bucket and GUGI-Grating made of PA-GF, MW 15/25 mm, class B 125, black, 0,5 m



Trash box with PE mud bucket and FIBRETEC design slotted grating in the colour Black, SW 9 mm, class C 250, locked, 0,5 m

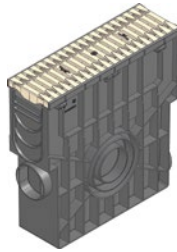

Trash box with PE mud bucket and FIBRETEC design slotted grating in the colour Sand SW 9 mm, class C 250, locked, 0,5 m

	Length mm	Width mm	Height mm	Weight kg	Item-No. galvanised	Item-No. stainless steel
NEW Trash box with plastic bucket and longitudinal grating, bar distance 10 mm, galvanised, locked, 0,5 m	500	160	504	6,72	47129	47139
Trash box with galvanised mud bucket and GUGI-Grating made of PA-GF, MW 15/25 mm, class B 125, black, 0,5 m	500	160	504	5,85	47053	-
Trash box with plastic mud bucket and mesh grating MW 30/10 mm, class B 125, locked, 0,5 m	500	160	504	6,40	47052	47059
Trash box with PE mud bucket and FIBRETEC design slotted grating, in the colour Black, SW 9 mm, class C 250, locked, 0,5 m	500	160	504	5,89	47054	-
Trash box with PE mud bucket and FIBRETEC design slotted grating, in the colour Sand, SW 9 mm, class C 250, locked, 0,5 m	500	160	504	5,89	47408	-
Trash box with PE mud bucket and FIBRETEC design slotted grating, SW 9 mm, in the colour Fern, class C 250, locked, 0,5 m	500	160	504	5,89	47420	-
Trash box with PE mud bucket and FIBRETEC design slotted grating, SW 9 mm, in the colour Stone class C 250, locked, 0,5 m	500	160	504	5,89	47414	-
Trash box with PE mud bucket and with ductile longitudinal grating, SW 9 mm, KTL, class C 250, locked, 0,5 m	500	160	504	8,10	48655	-
Trash box with PE mud bucket and longitudinal ductile iron grating, SW 9 mm, galvanised, class C 250, locked, 0,5 m	500	160	504	8,10	48656	-
Trash box with PE mud bucket and slotted grating SW 80/10 mm, class C 250, locked, 0,5 m	500	160	504	7,07	47078	47088
Trash box with PE mud bucket and ductile design iron grating METROPOLIS, black, KTL-coated, locked, 0,5 m	500	160	504	9,53	48657	-
Trash box with PE mud bucket and longitudinal ductile iron grating, SW 9 mm, galvanised, class D 400, locked, 0,5 m	500	160	504	8,10	48654	-
Trash box with PE mud bucket and longitudinal ductile iron grating, SW 9 mm, KTL, class D 400, locked, 0,5 m	500	160	504	8,57	48653	-

The quality of stainless steel material corresponds to CNS 1.4301.

RECYFIX® PRO 100

Accessories

NEW Trash boxes, FIBRETEC Design gratings in new colours



Trash box with PE mud bucket and FIBRETEC design slotted grating SW 9 mm, in the colour water, class C 250, locked, 0,5 m

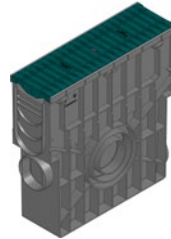
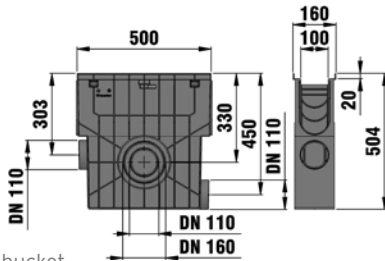

Trash box with PE mud bucket and FIBRETEC design slotted grating SW 9 mm, in the colour HAURATON petrol, class C 250, locked, 0,5 m

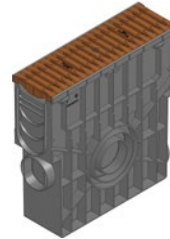

Trash box with PE mud bucket and FIBRETEC design slotted grating SW 9 mm, in the colour corten, class C 250, locked, 0,5 m



Trash box with PE mud bucket and FIBRETEC design slotted grating SW 9 mm, in the colour aluminium, class C 250, locked, 0,5 m



Trash box with PE mud bucket and FIBRETEC design slotted grating SW 9 mm, in the colour brick, class C 250, locked, 0,5 m



Trash box with PE mud bucket and FIBRETEC design slotted grating SW 9 mm, in the colour slate, class C 250, locked, 0,5 m

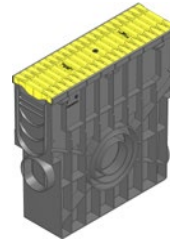

Trash box with PE mud bucket and FIBRETEC design slotted grating SW 9 mm, in the colour sun, class C 250, locked, 0,5 m

	Länge mm	Breite mm	Höhe mm	Gewicht kg	Art. Nr.
Trash box with PE mud bucket and FIBRETEC design slotted grating SW 9 mm, in the colour water, class C 250, locked, 0,5 m	500	160	504	5,47	47445
Trash box with PE mud bucket and FIBRETEC design slotted grating SW 9 mm, in the colour HAURATON petrol, class C 250, locked, 0,5 m	500	160	504	5,47	47446
Trash box with PE mud bucket and FIBRETEC design slotted grating SW 9 mm, in the colour corten, class C 250, locked, 0,5 m	500	160	504	5,47	47447
Trash box with PE mud bucket and FIBRETEC design slotted grating SW 9 mm, in the colour aluminium, class C 250, locked, 0,5 m	500	160	504	5,47	47448
Trash box with PE mud bucket and FIBRETEC design slotted grating SW 9 mm, in the colour brick, class C 250, locked, 0,5 m	500	160	504	5,47	47449
Trash box with PE mud bucket and FIBRETEC design slotted grating SW 9 mm, in the colour slate, class C 250, locked, 0,5 m	500	160	504	5,47	47450
Trash box with PE mud bucket and FIBRETEC design slotted grating SW 9 mm, in the colour sun, class C 250, locked, 0,5 m	500	160	504	5,47	47452

RECYFIX® PRO 100

NEW Trash boxes, **FIBRETEC** Design gratings in new colours, with slip resistance class R11

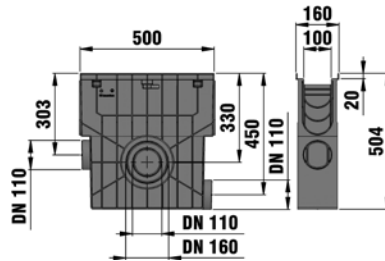

Trash box with PE mud bucket and FIBRETEC design slotted grating SW 9 mm, black, locked, class C 250, slip resistance class R11, 0,5 m

	Länge mm	Breite mm	Höhe mm	Gewicht kg	Art. Nr.
Trash box with PE mud bucket and FIBRETEC design slotted grating SW 9 mm, black, locked, class C 250, slip resistance class R11, 0,5 m	500	160	504	5,48	10223

RECYFIX®
PRO

RECYFIX®
PLUS

RECYFIX®
STANDARD

Facade Drainage

SLOTTED
CHANNELS

RECYFIX® POINT
FASERFIX® POINT

RECYFIX®
GREEN

TOP X

RECYFIX® PRO 100

Accessories

End caps



End cap closed
for type 01



End cap made of PP
with outlet DN/OD 110,
type 01

	Length mm	Width mm	Height mm	Weight kg	Item No.
End cap closed for type 01	-	160	124	0,04	48681
End cap made of PP with outlet DN/OD 110, type 01	-	160	201	0,08	48691
End cap closed for type 010	-	160	176	0,05	47082
End cap made of PP with outlet DN/OD 110, type 010	-	160	201	0,11	47093
End cap made of PP, type 020	-	160	250	0,12	48683
End cap made of PP with outlet DN/OD 110, type 020	-	160	250	0,12	48695
End cap for type 75	-	160	61	0,03	47097
End cap for type 95	-	160	81	0,04	47098

NEW PVC-U

	Length mm	Width mm	Height mm	Weight kg	Item No.
PVC-U pipe 45°, DA 110, shortened	186	110	160	0,24	1022
PVC-U pipe 45°, DA 160, shortened	256	160	229	0,30	33066
PVC-U 2000 pipe 45°, DA 110, shortened	209	110	175	0,25	33050
PVC-U 2000 pipe 45°, DA 160, shortened	288	160	249	0,71	33068
PVC-U pipe 87,5°, DA 110, shortened	180	110	184	0,30	1023
PVC-U pipe 87,5°, DA 160, shortened	152	160	258	0,84	33067
PVC-U 2000 pipe 87,5°, DA 110, shortened	189	110	199	0,41	33049
PVC-U 2000 pipe 87,5°, DA 160, shortened	266	160	278	0,82	33069

RECYFIX® PRO 100

Further accessories



Foul air trap for RECYFIX trash box 100



Foul air trap, vertical, DN/OD 110



Foul air trap set, vertical DN/OD 110 for RECYFIX 100



Mud bucket vertical made of modified composite for outlet DN/OD 110, black

	Length mm	Width mm	Height mm	Weight kg	Item No.
Foul air trap for RECYFIX trash box 100	75	78	135	0,08	967
Foul air trap, vertical, DN/OD 110	-	187	181	0,56	40295
Foul air trap set, vertical DN/OD 110 for RECYFIX 100	-	-	203	0,44	40294
Foul air trap DN/OD 110, outside	-	-	-	0,37	961
Adaptor for DN/OD 75 to PVC-U pipe DN/OD 110	-	-	-	0,12	1193
Mud bucket vertical made of modified composite for outlet DN/OD 110, black	100	100	85	0,04	40293
Step Fall Adapter for step slope, from type 01 to type 010, from type 010 to type 020	189	108	88	0,21	48790
Universal sealant/adhesive Siga-Meltell® 320 black**	-	-	-	0,97	19051
Tubular pistol for universal sealant/adhesive Siga-Meltell® 320 black	-	-	-	1,30	6891
Holesaw, Ø 102 mm, with tool holder for a driller	-	-	-	0,60	980

****Amount needed for Type 020: approx. 22 ml per joint**

RECYFIX®
PRO

RECYFIX®
PLUS

RECYFIX®
STANDARD

Facade Drainage

SLOTTED
CHANNELS

RECYFIX® POINT
FASERFIX® POINT

RECYFIX®
GREEN

TOP X

Grating options **RECYFIX PRO 150**



Longitudinal ductile iron gratings, KTL

Bar distance: 9 mm

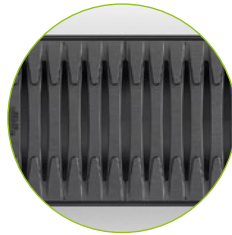
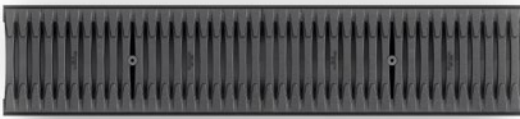

FIBRETEC Slotted gratings, composite material

Bar distance: 9 mm

Grating options **RECYFIX PRO 200**



Longitudinal ductile iron gratings, KTL

Bar distance: 9 mm

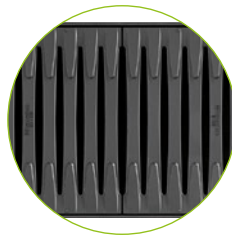

FIBRETEC Slotted gratings, composite material

Bar distance: 9 mm

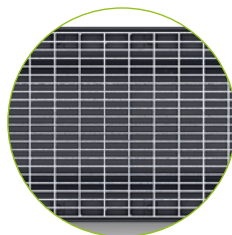
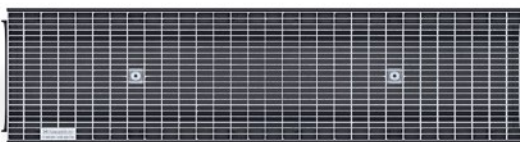

Mesh gratings, galvanised and stainless steel

Bar distance: 30 x 10 mm

RECYFIX®PRO 150

Combi article

RECYFIX®PRO 150, class B 125

Type 01 with FIBRETEC design slotted grating, SW 9 mm, in the colour black, locked, 1,0 m

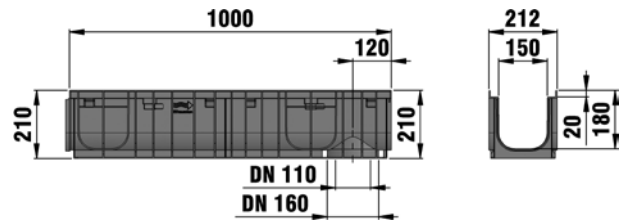
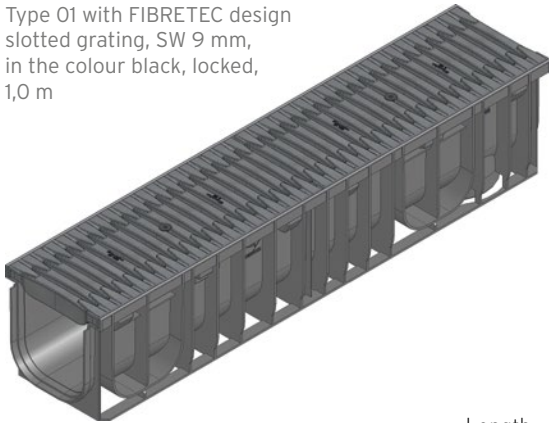

	Length mm	Width mm	Height mm	Internal channel cross-sect. cm ²	Intake cross-sect. cm ² /m	Weight kg	Item-No. galvanised	Item-No. stainless steel
Type 01 with FIBRETEC design slotted grating, SW 9 mm, in the colour black, locked, 1,0 m	1000	212	210	230	500	7,40	47135	-
Type 0105 with FIBRETEC design slotted grating, SW 9 mm, in the colour black, locked, 0,5 m	500	212	210	230	500	3,70	47136	-
Type 115 with FIBRETEC design slotted grating, SW 9 mm, in the colour black, locked, 1,0 m	1000	212	115	116	500	6,12	47133	-
Type 01 with mesh grating, MW 30/10 mm, locked, 1,0 m	1000	212	210	230	1490	8,60	47140	47141
Type 0105 with mesh grating, MW 30/10 mm, locked, 0,5 m	500	212	210	230	1468	4,36	47147	47148
NEW Type 115 with mesh grating MW 30/10, 1,0 m	1000	212	115	116	1490	7,35	47132	47138

The quality of stainless steel material corresponds to CNS 1.4301.

RECYFIX® PRO 150

RECYFIX® PRO 150, class C 250

Type 115 with longitudinal ductile iron grating SW 9 mm, KTL-coated, locked, 1,0 m

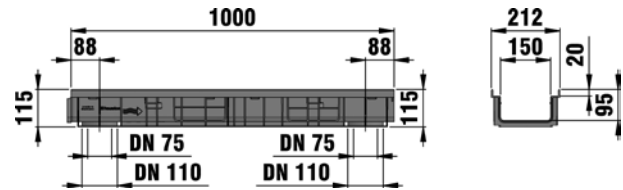
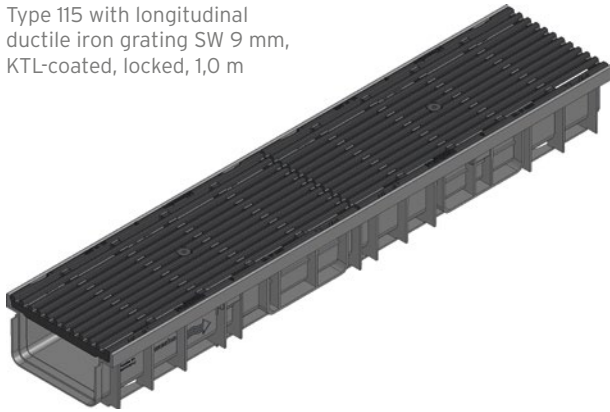

	Length mm	Width mm	Height mm	Internal channel cross-sect. cm ²	Intake cross-sect. cm ² /m	Weight kg	Item No.
Type 01 with longitudinal ductile iron grating SW 9 mm, KTL-coated, locked, 1,0 m	1000	212	210	230	740	17,20	47131
Type 0105 with longitudinal ductile iron grating SW 9 mm, KTL-coated, locked, 1,0 m	500	212	210	230	740	8,63	47137
Type 115 with longitudinal ductile iron grating SW 9 mm, KTL-coated, locked, 1,0 m	1000	212	115	116	740	15,88	47134
Type 01 with FIBRETEC design slotted grating SW 9 mm, in the colour black, locked, 1,0 m	1000	212	210	230	500	7,38	47111
Type 0105 with FIBRETEC design slotted grating SW 9 mm, in the colour black, locked, 0,5 m	500	212	210	230	500	3,69	47112
Type 115 with FIBRETEC design slotted grating SW 9 mm, in the colour black, locked, 1,0 m	1000	212	115	116	500	6,16	47110

RECYFIX® PRO 150

Accessories

Trash boxes

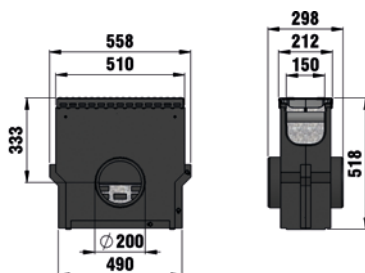

Trash box with galvanised mud bucket and FIBRETEC design slotted grating, black, SW 9 mm, class B 125, locked, 0,5 m

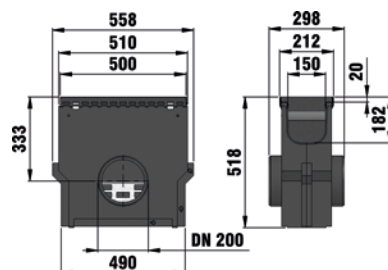

Trash box with galvanised mud bucket and longitudinal ductile iron grating SW 9 mm, KTL, class C 250, locked, 0,5 m

	Length mm	Width mm	Height mm	Weight kg	Item-No. galvanised	Item-No. stainless steel
Trash box with galvanised mud bucket and FIBRETEC design slotted grating, black, SW 9 mm, class B 125, locked, 0,5 m	500	212	518	18,70	47153	-
Trash box with galvanised mud bucket, mesh grating MW 30/10 mm, class B 125, locked, 0,5 m	500	212	518	19,37	47155	47156
Trash box with galvanised mud bucket and longitudinal ductile iron grating SW 9 mm, KTL, class C 250, locked, 0,5 m	500	212	518	23,62	47154	-
Trash box with galvanised mud bucket and FIBRETEC design slotted grating SW 9 mm, in the colour black, class C 250, locked, 0,5 m	500	212	518	18,72	47152	-

The quality of stainless steel material corresponds to CNS 1.4301.

End caps

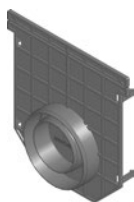

End cap combined, PP with outlet DN/OD 75/110 for type 01



End cap closed, type 115

	Length mm	Width mm	Height mm	Weight kg	Item No.
End cap combined, PP with outlet DN/OD 75/110 for type 01	-	210	218	0,14	40591
End cap closed, type 115	-	208	100	0,04	47197

RECYFIX® PRO 150

NEW PVC-U

	Length mm	Width mm	Height mm	Weight kg	Item No.
PVC-U pipe 45°, DA 110, shortened	186	110	160	0,24	1022
PVC-U pipe 45°, DA 160, shortened	256	160	229	0,30	33066
PVC-U pipe 45°, DA 200, cutting	323	200	285	1,16	33298
PVC-U 2000 pipe 45°, DA 110, shortened	209	110	175	0,25	33050
PVC-U 2000 pipe 45°, DA 160, shortened	288	160	249	0,71	33068
PVC-U pipe 87,5°, DA 110, shortened	180	110	184	0,30	1023
PVC-U pipe 87,5°, DA 160, shortened	152	160	258	0,84	33067
PVC-U pipe 87,5°, DA 200, cutting	321	200	324	1,47	33299
PVC-U 2000 pipe 87,5°, DA 110, shortened	189	110	199	0,41	33049
PVC-U 2000 pipe 87,5°, DA 160, shortened	266	160	278	0,82	33069
PVC-U 2000 pipe 87,5°, DA 200, cutting	316	200	352	1,47	33309

Further accessories



Foul air trap, vertical,
DN/OD 110



Foul air trap set, vertical
DN/OD 110 for RECYFIX 100



Mud bucket vertical
made of modified composite
for outlet DN/OD 110, black

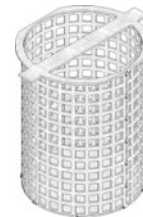

Mud bucket for outlet
DN/OD 160

	Length mm	Width mm	Height mm	Weight kg	Item No.
Foul air trap, vertical, DN/OD 110	-	187	181	0,56	40295
Foul air trap set, vertical DN/OD 110 for RECYFIX 100	-	-	203	0,44	40294
Mud bucket vertical made of modified composite for outlet DN/OD 110, black	100	100	85	0,04	40293
Mud bucket vertical made of modified composite for outlet DN/OD 160, black	-	-	-	0,13	845
Mud bucket for outlet DN/OD 160	-	-	180	0,82	2191
Universal sealant/adhesive Siga-Meltell® 320 black**	-	-	-	0,97	19051
Tubular pistol for universal sealant/adhesive Siga-Meltell® 320 black	-	-	-	1,30	6891
Holesaw, Ø 102 mm, with tool holder for a drill	-	-	-	0,60	980

**Amount needed for Type O1: approx. 17 ml per joint

RECYFIX®
PRO

RECYFIX®
PLUS

RECYFIX®
STANDARD

Facade Drainage

SLOTTED
CHANNELS

RECYFIX® POINT
FASERFIX® POINT

RECYFIX®
GREEN

TOP X

Grating options **RECYFIX PRO 150**



Longitudinal ductile iron gratings, KTL

Bar distance: 9 mm

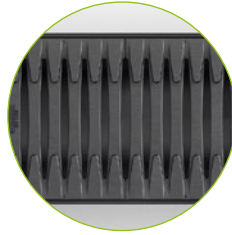
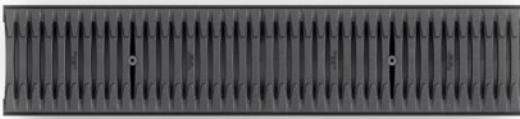

FIBRETEC Slotted gratings, composite material

Bar distance: 9 mm

Grating options **RECYFIX PRO 200**



Longitudinal ductile iron gratings, KTL

Bar distance: 9 mm

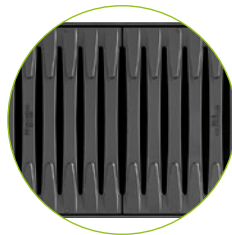

FIBRETEC Slotted gratings, composite material

Bar distance: 9 mm

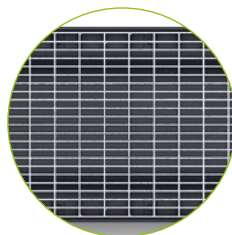
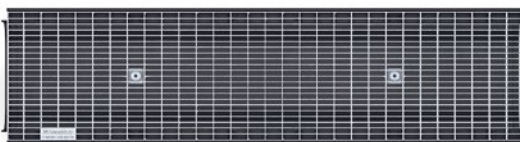

Mesh gratings, galvanised and stainless steel

Bar distance: 30 x 10 mm



**Ductile iron gratings,
G-TEC**

Bar distance: 2 x 85 x 9 mm

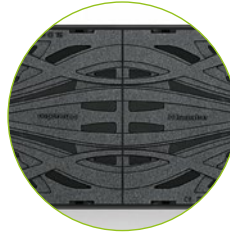

**Ductile iron grating,
METROPOLIS, KTL**

Grating options
RECYFIX PRO 300

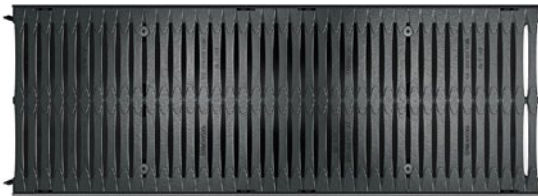

**Ductile iron gratings,
G-TEC**

Bar distance: 2 x 141 x 9 mm

RECYFIX® PRO
RECYFIX® PLUS
RECYFIX® STANDARD
Facade Drainage
SLOTTED CHANNELS
RECYFIX® POINT FASERFIX® POINT
RECYFIX® GREEN
TOP X

RECYFIX®PRO 200

Combi article

RECYFIX®PRO 200, class B 125

Type 010 with FIBRETEC design slotted grating, SW 9 mm, in the colour black, locked, 1,0 m

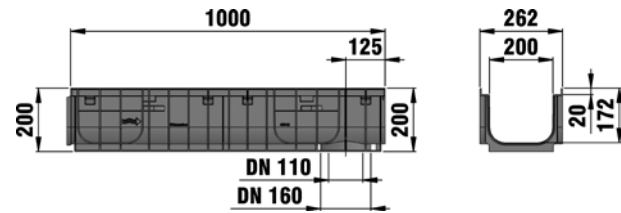

Type 115 with FIBRETEC design slotted grating, SW 9 mm, in the colour black, locked, 1,0 m

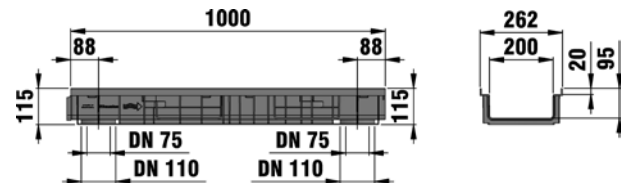
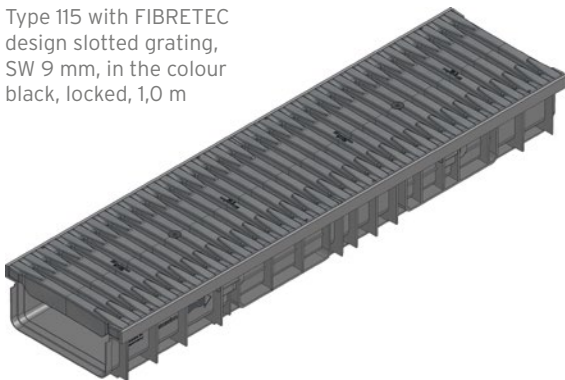

	Length mm	Width mm	Height mm	Internal channel cross-sect. cm ²	Intake cross-sect. cm ² /m	Weight kg	Item-No. galvanised	Item-No. stainless steel
Type 010 with FIBRETEC design slotted grating, SW 9 mm, in the colour black, locked, 1,0 m	1000	262	200	294	656	8,29	47246	-
Type 115 with FIBRETEC design slotted grating, SW 9 mm, in the colour black, locked, 1,0 m	1000	262	115	150	656	7,03	47233	-
Typ 010 with mesh grating, MW 30/10 mm, locked, 0,5 m	1000	262	200	294	1912	11,00	47248	47249
Type 01005 with mesh grating MW 30/10 mm, locked, 0,5 m	500	262	200	294	1912	5,14	47243	47244
NEW Type 115 with mesh grating MW 30/10, 1,0 m	1000	262	115	150	1873	10,08	47235	47236

The quality of stainless steel material corresponds to CNS 1.4301.

RECYFIX® PRO 200

RECYFIX® PRO 200, class C 250

Type 010 with longitudinal ductile iron grating, SW 9 mm, KTL-coated, locked, 1,0 m

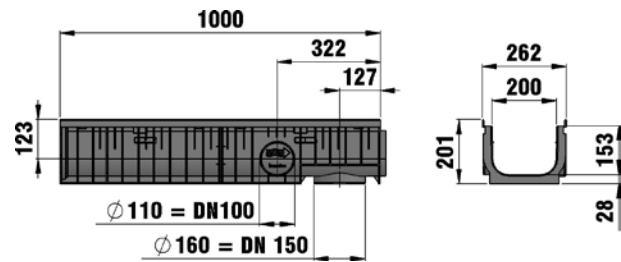
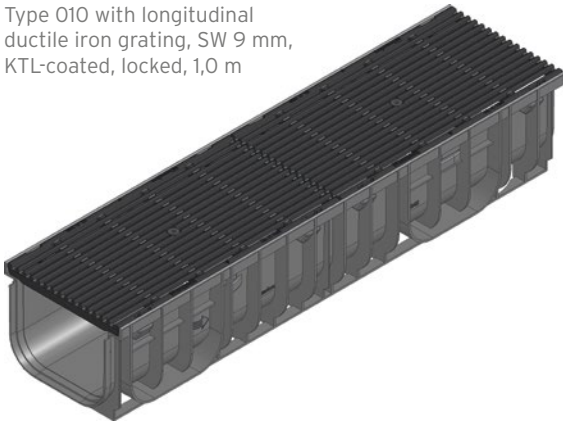

Type 115 with longitudinal ductile iron grating, SW 9 mm, KTL-coated, locked, 1,0 m

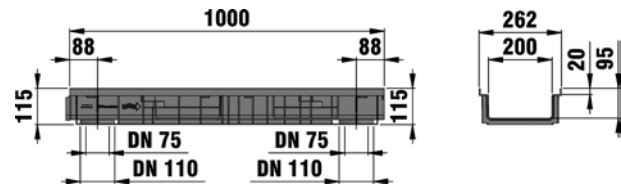
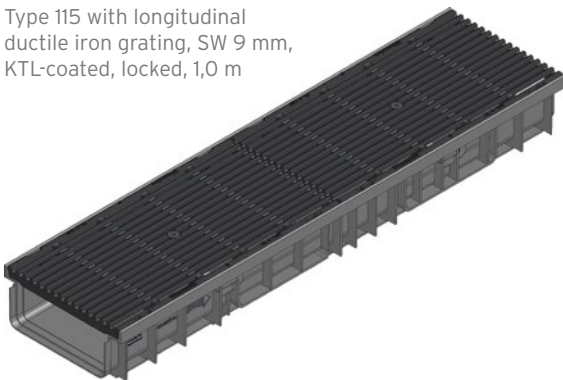

	Length mm	Width mm	Height mm	Internal channel cross-sect. cm ²	Intake cross-sect. cm ² /m	Weight kg	Item No.
--	--------------	-------------	--------------	---	---	--------------	-------------

Type 010 with longitudinal ductile iron grating, SW 9 mm, KTL-coated, locked, 1,0 m	1000	262	200	294	951	22,56	47247
Type 115 with longitudinal ductile iron grating, SW 9 mm, KTL-coated, locked, 1,0 m	1000	262	115	150	951	21,63	47234
Type 010 with G-TEC Ductile iron grating, SW 9 mm, KTL-coated, locked, 1,0 m	1000	262	200	294	595	20,60	47240
Type 115 with G-TEC Ductile iron grating, SW 9 mm, KTL-coated, locked, 1,0 m	1000	262	115	150	595	19,30	47231

Channels with solid ductile iron covers (closed) can be found in the range SERVICE CHANNELS

RECYFIX®
PRO

RECYFIX®
PLUS

RECYFIX®
STANDARD

Facade Drainage

SLOTTED
CHANNELS

RECYFIX® POINT
FASERFIX® POINT

RECYFIX®
GREEN

TOP X

RECYFIX®PRO 200

Combi article

RECYFIX®PRO 200, class D 400

Type 010 with ductile iron design grating METROPOLIS, black, KTL-coated, locked, 1,0 m

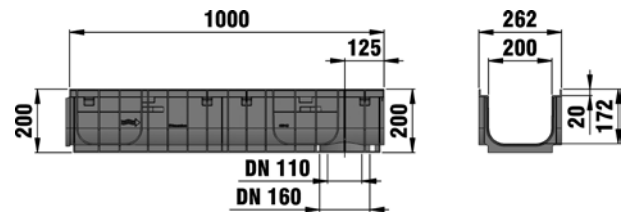
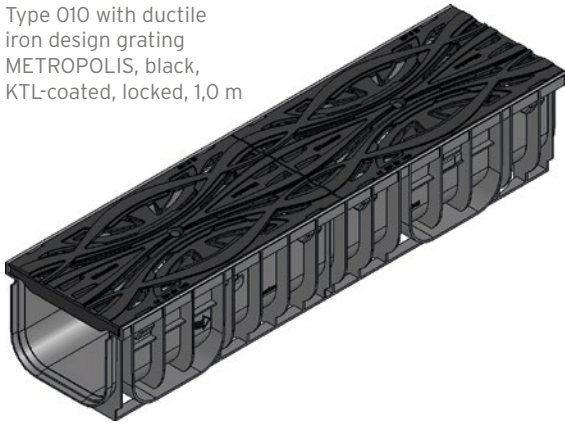

Type 010 with G-TEC Ductile iron grating, SW 9 mm, KTL-coated, locked, 1,0 m

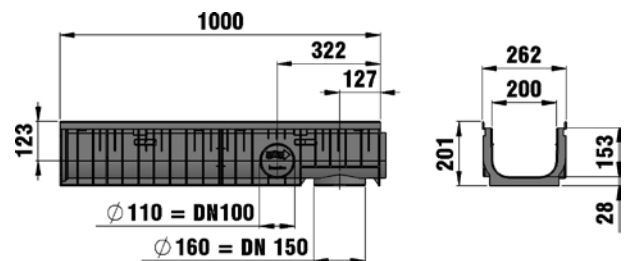

	Length mm	Width mm	Height mm	Internal channel cross-sect. cm ²	Intake cross-sect. cm ² /m	Weight kg	Item No.
--	--------------	-------------	--------------	---	---	--------------	-------------

Type 01005 with ductile iron design grating METROPOLIS, black, KTL-coated, locked, 0,5 m	500	262	200	294	279	12,30	47273
Type 010 with ductile iron design grating METROPOLIS, black, KTL-coated, locked, 1,0 m	1000	262	200	294	279	23,80	47272
Type 115 with ductile iron design grating METROPOLIS, black, KTL-coated, locked, 1,0 m	1000	262	115	150	279	23,80	47271
Type 010 with G-TEC Ductile iron grating, SW 9 mm, KTL-coated, locked, 1,0 m	1000	262	200	294	595	20,60	47245
Type 115 with G-TEC Ductile iron grating, SW 9 mm, KTL-coated, locked, 1,0 m	1000	262	115	150	595	19,30	47232

RECYFIX® PRO 200

Accessories

Trash boxes

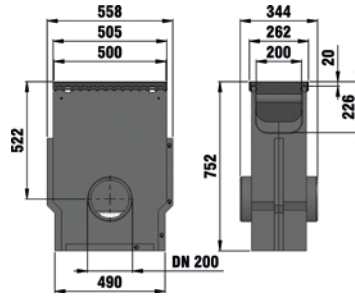

Trash box with galvanised mud bucket and FIBRETEC design slotted grating, SW 9 mm, black, class B 125, locked, 0,5 m



Trash box with PE mud bucket and ductile iron design grating METROPOLIS, black, KTL-coated, locked, 0,5 m

	Length mm	Width mm	Height mm	Weight kg	Item-No. galvanised	Item-No. stainless steel
Trash box with galvanised mud bucket and FIBRETEC design slotted grating, SW 9 mm, black, class B 125, locked, 0,5 m	500	262	752	28,90	47253	-
Trash box with galvanised mud bucket and mesh grating MW 30/30 mm, class B 125, locked, 0,5 m	500	262	752	30,05	47256	47257
Trash box with galvanised mud bucket and longitudinal ductile iron grating SW 9 mm, KTL-coated, class C 250, locked, 0,5 m	500	262	752	36,20	47254	-
Trash box with galvanised mud bucket and G-TEC Ductile iron grating, SW 9 mm, KTL-coated, class C 250, locked, 0,5 m	500	262	752	35,35	47252	-
Trash box with galvanised mud bucket and G-TEC Ductile iron grating, black, SW 9 mm, class D 400, locked, 0,5 m	500	262	752	35,35	47255	-
Trash box with PE mud bucket and ductile iron design grating METROPOLIS, black, KTL-coated, locked, 0,5 m	500	262	752	37,20	47278	-

The quality of stainless steel material corresponds to CNS 1.4301.

RECYFIX® PRO 200

Accessories

End caps



End cap closed,
type 115

	Length mm	Width mm	Height mm	Weight kg	Item No.
End cap combined made of PP closed / with outlet DN/OD 110, type 010	-	258	217	0,20	41387
End cap closed, type 115	-	262	100	0,06	47297

NEW PVC-U

	Length mm	Width mm	Height mm	Weight kg	Item No.
PVC-U pipe 45°, DA 110, shortened	186	110	160	0,24	1022
PVC-U pipe 45°, DA 160, shortened	256	160	229	0,30	33066
PVC-U pipe 45°, DA 200, cutting	323	200	285	1,16	33298
PVC-U 2000 pipe 45°, DA 110, shortened	209	110	175	0,25	33050
PVC-U 2000 pipe 45°, DA 160, shortened	288	160	249	0,71	33068
PVC-U pipe 87,5°, DA 110, shortened	180	110	184	0,30	1023
PVC-U pipe 87,5°, DA 160, shortened	152	160	258	0,84	33067
PVC-U pipe 87,5°, DA 200, cutting	321	200	324	1,47	33299
PVC-U 2000 pipe 87,5°, DA 110, shortened	189	110	199	0,41	33049
PVC-U 2000 pipe 87,5°, DA 160, shortened	266	160	278	0,82	33069
PVC-U 2000 pipe 87,5°, DA 200, cutting	316	200	352	1,47	33309

RECYFIX® PRO 200

Further accessories



Mud bucket vertical made of modified composite for outlet DN/OD 110, black



Mud bucket for outlet DN/OD 160



Foul air trap, vertical, DN/OD 110



Foul air trap set, vertical DN/OD 110 for RECYFIX 100

	Length mm	Width mm	Height mm	Weight kg	Item No.
Mud bucket vertical made of modified composite for outlet DN/OD 110, black	100	100	85	0,04	40293
Mud bucket for outlet DN/OD 160	-	-	180	0,82	2191
Foul air trap, vertical, DN/OD 110	-	187	181	0,56	40295
Foul air trap set, vertical DN/OD 110 for RECYFIX 100	-	-	203	0,44	40294
Universal sealant/adhesive Siga-Meltell® 320 black**	-	-	-	0,97	19051
Tubular pistol for universal sealant/adhesive Siga-Meltell® 320 black	-	-	-	1,30	6891
Holesaw, Ø 102 mm, with tool holder for a driller	-	-	-	0,60	980

**Amount needed for Type O10: approx. 18 ml per joint



**Ductile iron gratings,
G-TEC**

Bar distance: 2 x 85 x 9 mm

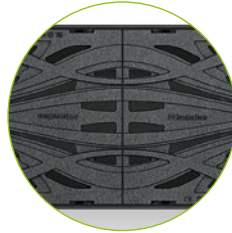

**Ductile iron grating,
METROPOLIS, KTL**

Grating options
RECYFIX PRO 300

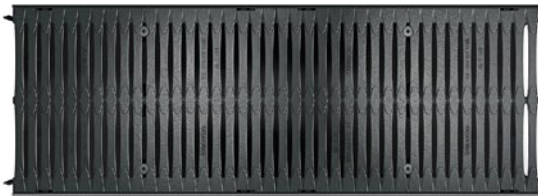

**Ductile iron gratings,
G-TEC**

Bar distance: 2 x 141 x 9 mm

RECYFIX® PRO
RECYFIX® PLUS
RECYFIX® STANDARD
Facade Drainage
SLOTTED CHANNELS
RECYFIX® POINT FASERFIX® POINT
RECYFIX® GREEN
TOP X

RECYFIX®PRO 300

Combi article

RECYFIX®PRO 300, class C 250

Type 010 with G-TEC
Ductile iron grating
SW 9 mm, KTL-coated,
locked, 1,0 m

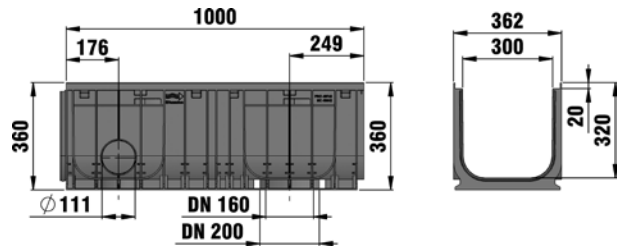
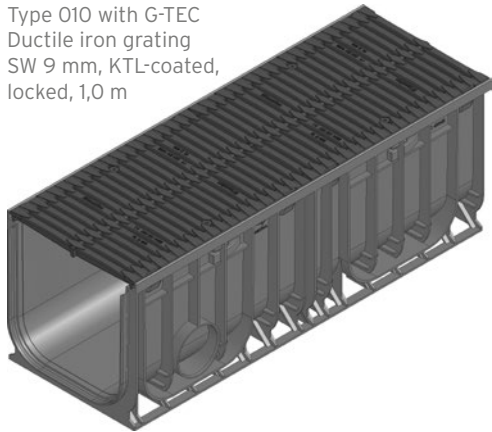

Length mm	Width mm	Height mm	Internal channel cross-sect. cm ²	Intake cross-sect. cm ² /m	Weight kg	Item No.
--------------	-------------	--------------	---	---	--------------	-------------

Type 010 with G-TEC Ductile iron grating SW 9 mm, KTL-coated, locked, 1,0 m	1000	362	360	873	960	38,10	49744
---	------	-----	-----	-----	-----	-------	-------

Channels with solid ductile iron covers (closed) can be found in the range SERVICE CHANNELS

RECYFIX®PRO 300, class D 400

Type 010 with G-TEC
Ductile iron grating
SW 9 mm, KTL-coated,
locked, 1,0 m

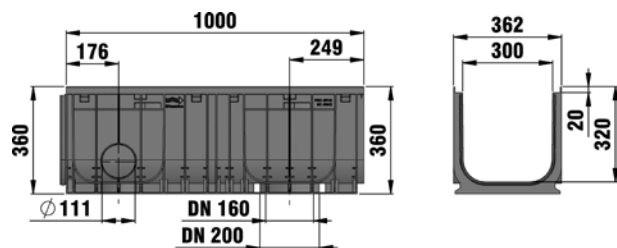
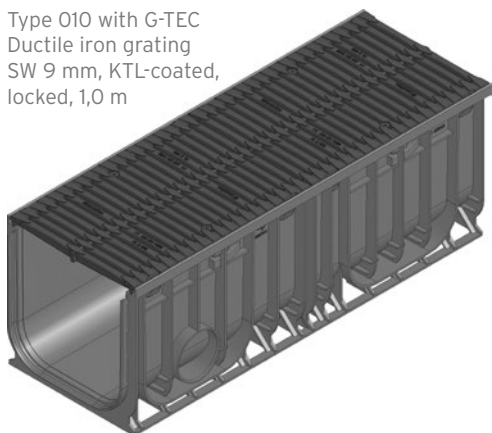

Length mm	Width mm	Height mm	Internal channel cross-sect. cm ²	Intake cross-sect. cm ² /m	Weight kg	Item No.
--------------	-------------	--------------	---	---	--------------	-------------

Type 010 with G-TEC Ductile iron grating SW 9 mm, KTL-coated, locked, 1,0 m	1000	362	360	873	960	38,10	49745
---	------	-----	-----	-----	-----	-------	-------

RECYFIX® PRO 300

Accessories

Trash boxes

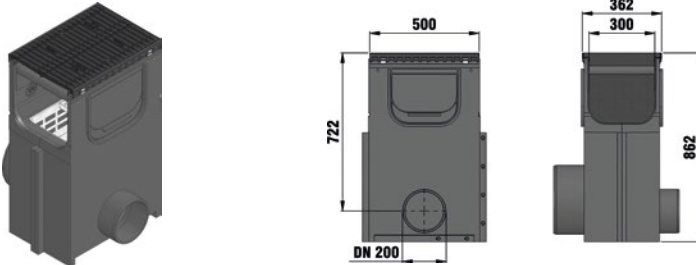

Trash box with galvanised mud bucket and G-TEC Ductile iron grating, SW 2 x 141/9 mm, KTL-coated, class C 250, locked, with PVC-U pipe outlet DN/OD 200, 0,5 m

	Length mm	Width mm	Height mm	Weight kg	Item No.
Trash box with galvanised mud bucket and G-TEC Ductile iron grating, SW 2 x 141/9 mm, KTL-coated, class C 250, locked, with PVC-U pipe outlet DN/OD 200, 0,5 m	500	362	862	51,96	32329
Trash box with galvanised mud bucket and G-TEC Ductile iron grating, SW 2 x 141/9 mm, KTL-coated, class C 250, locked, with PVC-U pipe outlet DN/OD 315, 0,5 m	500	362	862	51,96	32336

RECYFIX® PRO 300

Accessories

End caps



End cap closed, galvanised,
type 010

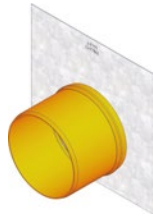

End cap with horizontal
PVC-U pipe outlet DN/OD 200,
galvanised, type 010

	Length mm	Width mm	Height mm	Weight kg	Item No.
End cap closed, galvanised, type 010	-	360	360	1,87	49783
End cap with horizontal PVC-U pipe outlet DN/OD 200, galvanised, type 010	-	360	360	2,55	49791

NEW PVC-U

	Length mm	Width mm	Height mm	Weight kg	Item No.
PVC-U pipe 45°, DA 160, shortened	256	160	229	0,30	33066
PVC-U pipe 45°, DA 200, cutting	323	200	285	1,16	33298
PVC-U 2000 pipe 45°, DA 160, shortened	288	160	249	0,71	33068
PVC-U 2000 pipe 45°, DA 200, cutting	358	200	324	1,30	33308
PVC-U pipe 87,5°, DA 160, shortened	152	160	258	0,84	33067
PVC-U pipe 87,5°, DA 200, cutting	321	200	324	1,47	33299
PVC-U 2000 pipe 87,5°, DA 160, shortened	266	160	278	0,82	33069
PVC-U 2000 pipe 87,5°, DA 200, cutting	316	200	352	1,47	33309

RECYFIX® PRO 300

Further accessories



Mud bucket for outlet
DN/OD 160

	Length mm	Width mm	Height mm	Weight kg	Item No.
Universal sealant/adhesive Siga-Meltell® 320 black**	-	-	-	0,97	19051
Tubular pistol for universal sealant/adhesive Siga-Meltell® 320 black	-	-	-	1,30	6891
Mud bucket for outlet DN/OD 160	-	-	180	0,82	2191

****Amount needed for Type 010: approx. 32 ml per joint**

RECYFIX®
PRO

RECYFIX®
PLUS

RECYFIX®
STANDARD

Facade Drainage

SLOTTED
CHANNELS

RECYFIX® POINT
FASERFIX® POINT

RECYFIX®
GREEN

TOP X